

STEERING PRODUCTS™



STEMCO® KAISER™ STEERING COMPONENTS CATALOG



STEMCO®
Making the Roadways Safer®

At STEMCO® we engineer advanced commercial vehicle solutions and create exceptional customer experiences in our passion to make the roadways safer. STEMCO Kaiser is a product line of STEMCO, and manufacturers superior quality solutions for the commercial vehicle industry. STEMCO Kaiser has the industry's most extensive offering of steering knuckle king pin kits, as well as pre-sized, hardened sleeves to repair worn axle eyes.

STEMCO KAISER™ KING PIN KITS

Kits contain all necessary components to complete a king pin repair. STEMCO Kaiser king pin kits offer three kit options to meet all customer needs.

QwikKit® – No need to ream, ease of installation, and 300% better lubrication with extreme long life. QwikKit is the original grease grooved King Pin and spiral steel bushing design. Always use the STEMCO Kaiser QwikKit.

PlusKit® – Pre-sized bronze bushing kit, which allows for the lowest total repair cost in the market. Less down time and labor costs due to the bushing's no ream feature. Insist on PlusKits the no ream bronze bushing product that does not compromise quality.

Econo Kit™ – Top quality bronze bushings and quality king pins allow for a customizable individual fit, are competitively priced and offers consistent components in every kit.

STEMCO KAISER APE SLEEVES

Axle bore issues are a common problem when doing a king pin repair and fixing the problem is essential.

STEMCO Kaiser APE sleeves are easy to install and harder than the axle bore to provide extended life. APE sleeves also have the lock pin slots pre-cut for a trouble free installation.

VMRS CODES

3-DIGIT	6-DIGIT	9-DIGIT	DESCRIPTION
011	011-001	011-001-061	Tie Rod, Tube & Ends Assembly
011	011-001	011-001-031	End – Tie Rod
011	011-001	011-001-030	Tube – Tie Rod, Non-Driven, Front Axle
011	011-001	011-001-010	Repair Kit – King Pin

WHAT MAKES OUR PRODUCTS DIFFERENT?

STEMCO Kaiser has been an industry institution for over 60 years and is known as the premier provider of "no ream" King Pin solutions.

STEMCO Kaiser has a history of providing real world solutions to some of the industry's biggest problems. The QwikKit king pin kit has successfully provided four times the life of traditional king pin kits when used in the after-market. STEMCO Kaiser also offers an industry best technical training and support team, as well as live in shop training sessions.

STEMCO KAISER King Pin Kits, Bushings, and Axle Sleeves are proudly made in the USA and outperform, outlast and are simpler to install than other products on the market.

The STEMCO website and mobile application offer valuable reference and support tools for the STEMCO Kaiser product line.

Please visit www.stemco.com for additional resources and support. We also offer a live tech help-line to help find the right product, call us at **800-527-8492** or contact us via email at techservice@stemco.com.

CONTENTS ALPHABETICAL BY MAKE

STEERING KNUCKLE KING PIN KITS

Alliance Axle4
 Chevrolet 4-5
 Clark5
 Dodge.....6
 Eagle.....6
 Eaton6
 Eveley6
 Ford 6-9
 Freightliner9
 FWD.....9
 GMC9-11
 Hendrickson 11
 Hino11
 IMT / Ingersoll11
 International / Navistar 12-14
 Isuzu 14-15
 Kenworth..... 15
 KGI..... 15
 Kimble Mixer 15
 Link.....15
 Mack.....15-16
 MAN16
 MCI16
 Mc Neliu MTM.....16
 Meritor16-18
 Mitsubishi.....18
 New Flyer18
 Peterbilt.....18
 Ridewell.....19
 Spicer / Dana / Eaton.....19-21
 Sterling21
 Volvo21
 Watson & Chalin22
 White / Westport.....22
 Workhorse.....22

BUS STEERING KNUCKLE KING PIN KITS

Bluebird23
 Ford23
 Gillig23
 GMC Coach23
 International / Navistar24
 MAN24
 MCI24
 Meritor 24-25
 New Flyer25
 Thomas.....25
 King Pin Dimensions Interchange26

KING PIN SUPPORT INFORMATION AND PRODUCTS

Manufacturers Spindle Bore
 and Axle Bore Dimensions27
 King Pin Service Tools28

INTERCHANGE SECTION

King Pin Interchange.....29-42
 Bearing Interchange.....42
 Shim Pack Cross Reference43

COMPONENT PARTS SECTION

QwikKit®44-50
 PlusKit® 50-53
 QWIKTIE Interchange..... 54-65
 Axle Pro Equipment Cross-Reference Matrix 66-67

INDUSTRY LEADING WARRANTIES

STEMCO QwikKit king pin kits are now covered by a 4-year warranty and PlusKit king pin kits are covered by a 2-year warranty, providing you with peace of mind and confidence that your components are protected for the long-haul.

WARRANTY CLAIMS:

- The following procedure shall apply to all warranty claims:
- The end user must return all parts for which it intends to make a warranty claim to the authorized STEMCO Kaiser Distributor who sold it the parts in question, along with a properly filled out Warranty Claim Form.
 - End users can obtain a Warranty Claim Form by contacting their authorized STEMCO Kaiser Distributor, who may obtain such form from STEMCO Kaiser's Warranty department.
 - After obtaining a completed Warranty Claim Form from the end user, the STEMCO Kaiser Distributor must return to STEMCO Kaiser the following: (i) the parts in question, (ii) the completed Warranty Claim Form and (iii) a complete written history of the parts in question, including information concerning the vehicle from which the parts were removed.
 - The STEMCO Kaiser Distributor must ship the parts and all documentation prepaid to STEMCO Kaiser, 4599 Industrial Drive, Millington, Michigan, 48746 for service analysis.
 - Items deemed by STEMCO Kaiser to be defective under the terms of STEMCO Kaiser's warranty will be replaced. All claims will receive a service analysis report.

DISCLAIMER NOTICE:

The use of a manufacturer's name, product number and part description in this catalog is intended to assist our customers in identifying replacement parts. Names referenced in this catalog may be trademarks or trade names of their respective manufacturers or suppliers and are not intended to show affiliation between STEMCO and the owners of those names.

Every effort has been made to insure the accuracy of the information shown in this catalog. However, STEMCO assumes no liability for any errors or omissions in the information provided.

To order more catalogs, call and request Part #01-577-0002.









STEERING KNUCKLE KING PIN KITS

MODEL	AXLE	YEAR	OEM NO.	PIN TYPE	OEM SPEC	QWIKKIT NO. ¹	PLUSKIT NO. ²	ECONO KIT NO.	LIP SEAL/ BUSHING DRIVER INSTALLATION TOOL	AXLE SLEEVE USED WITH APE	APE CUTTER KIT USED
ALLIANCE AXLE											
	AF-6.0-2, AF-8.0-2		P6073300219KZ P6073300319KZ	B	1.771 x 8.06	K80A			ST70-30		
	AF-10.0-3, AF-12.0-3, AF-13.0-3, AF-13.3-3, AF-14.7-3		P6073300019KZ P6073300119KZ	B	1.771 x 9.23	K120A			ST70-30	92.120.01	84.122.05
			P6073300019KZ x 2 (roller bearings)	B	1.771 x 9.23	K121A			ST70-30	92.120.01	84.122.05
			P6073300119KZ x 2 (composite bearings)	B	1.771 x 9.23	K122A			ST70-30	92.120.01	84.122.05
	AF-16.0-5, AF-18.0-3, AF-20.3-3		P6073300419KZ P6073300519KZ	B	2.125 x 9.75	K160A			ST70-31		
CHEVROLET											
¾ & 1 Ton P20, P30		1960-1964	3854744	A	1.109 x 6.34	K51G			ST70-14		
		1964-1967	3858389 3927942	A	1.109 x 6.34	K51G			ST70-14		
	5000#	1986 to date	15522020 15584763	A	1.179 x 6.35	K56G	70.056.07		ST70-4	91.056.07	84.056.07
C30HD - Heavy Duty Pickup			15665666 88911968 88911987	A	1.179 x 6.35	K56G	70.056.07		ST70-4	91.056.07	84.056.07
	1 ½ Ton - C40, P40	5000# (F-050)	1964-1975	3858389 3927942	A	1.109 x 6.34	K51G		ST70-14		
		5000# (F-050)	1975-1990	722166	A	1.179 x 6.35	K55G	70.055.07	ST70-4	91.056.07	84.056.07
		7000# (F-070)	1963-1984	3927943 8885857	A	1.249 x 7.87	K70G	70.070.07	ST70-1		
1 ½ Ton & 2 Ton - C50, D50, L50, M50, N50, P50, S50, T50, C5D, Q50		5000# (F-050)	1963-1975	3829410 3927942	A	1.109 x 6.34	K51G		ST70-14		
		5000# (F-050)	1975-1990	722166	A	1.179 x 6.35	K55G	70.055.07	ST70-4	91.056.07	84.056.07
		7000# (F-070)	1965-1975	3838390 3927943	A	1.249 x 7.87	K70G	70.070.07	ST70-1		
		11000# (F-110)	1965-1970	2264897	E	1.609 x 9.75	K125G¹²		ST70-5		
		12000# (F-120)	1966-1973	2264897	E	1.609 x 9.75	K125G¹²		ST70-5		
	12000# (F-120D)	1975-1990	8885621	B	1.745 x 9.37	K121G⁷		ST70-11			
2 Ton - A60, B60, C60, D60, L60, M60, N60, P60, Q60, S60, T60, V60, X60, Y60		5000#	1963-1975	3858389 3927942	A	1.109 x 6.34	K51G		ST70-14		
		5000#	1975-1990	722166	A	1.179 x 6.35	K55G	70.055.07	ST70-4	91.056.07	84.056.07
		7000# (F-070) Some 6000#	1963-	3838390 3927943	A	1.249 x 7.87	K70G	70.070.07	ST70-1		
		11000# (F-110)	1965-1975	2264897	E	1.609 x 9.75	K125G¹²		ST70-5		
		12000# (F-120)	1966-1975	2264897	E	1.609 x 9.75	K125G¹²		ST70-5		
		12000# (F-120D)	1975-1990	8885621	B	1.745 x 9.37	K121G⁷		ST70-11		
		16000# (FL-901)	1971 to date	2452865	B	1.999 x 10.90	KH901L		ST70-12		
CLARK (INDUSTRIAL AXLES)											
F-553 Air Start/Gen. Carts				A	1.234 x 7.62	K98I	70.098.09	50.098.09	ST70-10		

MODEL	AXLE	YEAR	OEM NO.	PIN TYPE	OEM SPEC	QWIKKIT NO. ¹	PLUSKIT NO. ²	ECONO KIT NO.	LIP SEAL/ BUSHING DRIVER INSTALLATION TOOL	AXLE SLEEVE USED WITH APE	APE CUTTER KIT USED
CHEVROLET CONT.											
Top Kick - C - Series	6000# (FN9)		88936084	A	1.234 x 6.78	K60R			ST70-3	91.060.18	84.060.18
	7000# (FM7)		88936119	B	1.499 x 7.15	K70R	70.070.18		ST70-28		
	8000# (FM8)		88936011	B	1.499 x 7.50	K80R	70.080.18		ST70-28		
	10000# (FM6)			B	1.794 x 10.40	K120R	70.120.18		ST70-7		
	8100# (FL1)	1990 to date	12540328 15619560	G	1.614 x 8.00	K80G¹¹					
	9000# 11000# (FL2) 12000# (FS7)	1990 to date	12540329 15619561	G	1.889 x 9.20	K110G¹¹					
Top Kick - T - Series	14000# (FH0) 14500# (FL3) 14600# (FSD)	1990 to date	12540330 15619562	G	1.889 x 9.62	K120G¹¹					
	EFA18F3 16000#		12541348 3927942	A	1.872 x 9.96	K180E	70.180.05		ST70-23	91.180.05	84.147.05
2 ½ Ton - C70, C7D, H70, J70, R70, S70, S71, T70, W70	7000# (F-070)	1963 to date	3838390 3927943	A	1.249 x 7.87	K70G	70.070.07		ST70-1		
	11000# (F-110)	1962-1975	2264897	E	1.609 x 9.75	K125G¹²			ST70-5		
	12000# (F-120)	1966-1975	2264897	E	1.609 x 9.75	K125G¹²			ST70-5		
	12000# (F-120D)	1975 to date	8885621	B	1.745 x 9.37	K121G⁷			ST70-11		
	FF-932 13200#		15510849	B	1.794 x 10.39	K931L	70.931.12		ST70-7	92.961.12	84.122.05
	FG-943 14600#			B	1.794 x 10.39	KG931R	77.931.18		ST70-7	92.931.18	84.122.05
	18000# (FL-901)	1971 to date	2452865	B	1.999 x 10.90	KH901L			ST70-12		
2 ½ & 3 Ton - A80, C80, E80, H80, J80, L80, M80, N80, Q80	7000# (F-070)	1963 to date	3838390 3927943	A	1.249 x 7.87	K70G	70.070.07		ST70-1		
	11000# (F-110)	1962-1975	2264897	E	1.609 x 9.75	K125G¹²			ST70-5		
	12000# (F-120)	1966-1975	2264897	E	1.609 x 9.75	K125G¹²			ST70-5		
	12000# (F-120D)	1975 to date	8885621	B	1.745 x 9.37	K121G⁷			ST70-11		
	18000# (FL-901)	1971 to date	2452865	B	1.999 x 10.90	KH901L			ST70-12		
3 ½ Ton - D90, F90, H90, J90, M90, T90, W90	12000# (F-120)	1970-1975	2264897	E	1.609 x 9.75	K125G¹²			ST70-5		
	12000# (FE-900)	1970-1975	2264897	E	1.609 x 9.75	K125G¹²			ST70-5		
	12000# (F-120D)	1975 to date	8885621	B	1.745 x 9.37	K121G			ST70-11		
	18000# (FL-901)	1970 to date	2452865	B	1.999 x 10.90	KH901L			ST70-12		
	16000# (FL-931)	1973-1978	2036352	B	1.999 x 11.21	KH931L	78.931.12		ST70-12	92.931.12	84.931.12
CLARK (INDUSTRIAL AXLES)											
F-553 Air Start/Gen. Carts				A	1.234 x 7.62	K98I	70.098.09	50.098.09	ST70-10		

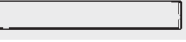
PIN TYPE CHART:

	A – SINGLE LOCK FLAT		C – SAME SIDE LOCK FLATS		G – STEP THREADED
	B – DOUBLE LOCK FLAT		E – TAPERED THREADED		H – NO LOCK FLATS
	F – TAPERED		J – SINGLE STEP		

1. STEMCO Kaiser QwikKit® feature patented spiral steel bushings. 2. STEMCO Kaiser PlusKit® feature pre-sized steel back bronze bushings. 3. Kit has composite bushings. 4. Modify spindles to receive end plates. 5. Bolt on cap. 6. Threaded cap. 7. Length of STEMCO Kaiser pin is 9 3/4". 8. STEMCO Kaiser pin is longer than OEM. 9. Torque Spec. for king pin nut is 230 ft/lbs. 10. Torque Spec. for king pin nut is 300 ft/lbs. 11. Torque Spec. for king pin nut is 406 ft/lbs. 12. Torque Spec. for king pin nut is 350/475 ft/lbs. 13. Includes end caps. 14. Torque Spec. for knuckle attachment bolts is 170-200 ft/lbs. 15. Kit uses special removal tool ST90-1.

FOR ALL QWIKKIT® – BUSHING "T" HANDLE WRENCHES

TOOL NO.	DESCRIPTION	TOOL NO.	DESCRIPTION
ST-100-1	Short "T" Handle Wrench	ST-100-3	Short "T" Handle Wrench
ST-100-2	Long "T" Handle Wrench	ST-100-4	Long "T" Handle Wrench
100M1-1	Replacement head	100M1-2	Replacement head

Above Wrenches will fit the bushings in most kits. The Following kits do not use wrenches: K80A, K120A, K120N, K150KG, K160A, K700T, K60U

Above Wrenches will fit the bushings in the following kits: K50F, K71F, K72F, K80G, K110G, K120G, K122V, K146E, K147E, K180E, K68Z, K69Z

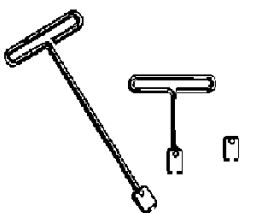

STEERING KNUCKLE KING PIN KITS

MODEL	AXLE	YEAR	OEM NO.	PIN TYPE	OEM SPEC	QWIKKIT NO. ¹	PLUSKIT NO. ²	ECONO KIT NO.	LIP SEAL/ BUSHING DRIVER INSTALLATION TOOL	AXLE SLEEVE USED WITH APE	APE CUTTER KIT USED
DODGE											
2 Ton - C500, D500, M500, R500, S500, PC500, PD500	7000#	1957-1973	1843208	B	1.234 x 7.43	K70D				ST70-10	
2 ½ Ton - C600, D600, L600, S600, PC600, PD600, C700, CT700, D700, L700, S700	7000#	1957-1973	1843208	B	1.234 x 7.43	K70D				ST70-10	
	7000#	1960-1973	1843208	B	1.234 x 7.43	K70D				ST70-10	
	9000#	1960-1973	1818726	B	1.433 x 8.50	KD901R	74.901.18			ST70-9	
	11000#	1960-1968	1643174	E	1.609 x 9.75	K125G¹²				ST70-5	
	12000#	1969-1971	2808618	B	1.794 x 9.12	K901L	70.901.12			ST70-7	
3 Ton - C800, CN800, CNT800, D800, NCT800, C850	7000#	1960-1973	1843208	B	1.234 x 7.43	K70D				ST70-10	
	9000#	1960 to date	1818726	B	1.433 x 8.50	KD901R	74.901.18			ST70-9	
	11000#	1960-1968	1643174	E	1.609 x 9.75	K125G¹²				ST70-5	
	12000#	1969-1977	2808618	B	1.794 x 9.12	K901L	70.901.12			ST70-7	
4 Ton - C900, CN900, CT900, CNT900, NC900, NCT900, VL900, VLT900	7000#	1960-1973	1843208	B	1.234 x 7.43	K70D				ST70-10	
	9000#	1960 to date	1818726	B	1.433 x 8.50	KD901R	74.901.18			ST70-9	
	11000#	1960-1968	1643174	E	1.609 x 9.75	K125G¹²				ST70-5	
	12000#	1969-1973	2808618	B	1.794 x 9.12	K901L	70.901.12			ST70-7	
	16000#	1974 to date		B	1.999 x 11.04	KH901L				ST70-12	
5 Ton - C1000, CT1000, DN1000, DNT1000, LN1000, LNT1000	7000#	1970-1973	1843208	B	1.234 x 7.43	K70D				ST70-10	
	9000#	1960 to date	1818726	B	1.433 x 8.50	KD901R	74.901.18			ST70-9	
	11000#	1960-1968	1643174	E	1.609 x 9.75	K125G¹²				ST70-5	
	12000#	1969-1973	2808618	B	1.794 x 9.12	K901L	70.901.12			ST70-7	
	16000#	1974 to date		B	1.999 x 11.04	KH901L				ST70-12	
EAGLE											
05	12000#		123	E	1.609 x 9.75	K125G¹²				ST70-5	
EATON (SEE SPICER / DANA / EATON)											
EVELEY											
	S2439-13 S3100-13 S3533			B	2.362 x 12.25	K300Y					
FORD											
E100, E250, E350		1975 to date	D5UZ-3111B D5UZ-3111D E0TZ-3111A	A	1.054 x 6.68	KE350F				ST70-15	
½ Ton (Twin-I-Beam)	2600# Manual Brakes	1975 to date	D5TZ-3111B	A	1.054 x 6.68	KE350F				ST70-15	
¾ Ton (Twin-I-Beam) F250 Conventional 2 wheel drive		1980-1986	E0TZ-3111A	A	1.054 x 6.68	KE350F				ST70-15	
1 Ton (Twin-I-Beam) F350 Conventional 2 wheel drive		1980-1986	E0TZ-3111A	A	1.054 x 6.68	KE350F				ST70-15	

PIN TYPE CHART:

	A – SINGLE LOCK FLAT		B – DOUBLE LOCK FLAT		C – SAME SIDE LOCK FLATS		D – TAPERED THREADED		E – TAPERED THREADED		F – TAPERED		G – STEP THREADED		H – NO LOCK FLATS		I – SINGLE STEP
--	----------------------	--	----------------------	--	--------------------------	--	----------------------	--	----------------------	--	-------------	--	-------------------	--	-------------------	--	-----------------

1. STEMCO Kaiser QwikKit® feature patented spiral steel bushings. 2. STEMCO Kaiser PlusKit® feature pre-sized steel back bronze bushings. 3. Kit has composite bushings. 4. Modify spindles to receive end plates. 5. Bolt on cap. 6. Threaded cap. 7. Length of STEMCO Kaiser pin is 9 3/4". 8. STEMCO Kaiser pin is longer than OEM. 9. Torque Spec. for king pin nut is 230 ft/lbs. 10. Torque Spec. for king pin nut is 300 ft/lbs. 11. Torque Spec. for king pin nut is 406 ft/lbs. 12. Torque Spec. for king pin nut is 350/475 ft/lbs. 13. Includes end caps. 14. Torque Spec. for knuckle attachment bolts is 170-200 ft/lbs. 15. Kit uses special removal tool ST90-1.

MODEL	AXLE	YEAR	OEM NO.	PIN TYPE	OEM SPEC	QWIKKIT NO. ¹	PLUSKIT NO. ²	ECONO KIT NO.	LIP SEAL/ BUSHING DRIVER INSTALLATION TOOL	AXLE SLEEVE USED WITH APE	APE CUTTER KIT USED
FORD CONT.											
F450 Super Duty		1988-1998	E8TZ-3111A	A	1.300 x 7.26	K71F				ST70-17	
1 ½ Ton B500, F500, LN500, N500, C500, P500	4700# - 5000#	1963 to date	C3TZ-3111A D2TZ-3111D	A	1.231 x 7.54	K50F⁴	70.053.06				
		1978-1979	C3TZ-3111A	A	1.231 x 7.54	K50F⁴	70.053.06			ST70-3	
1 ½ Ton C500, P500 C550, P600	4700# - 5000#	1970-1973	C7TZ-3111A	A	1.230 x 8.90	K70F⁴				ST70-3	
		1961-1969	B7TZ-3111B C2TZ-3111B	B	1.234 x 7.43	K70D				ST70-10	
		1970-1988	C7TZ-3111A	A	1.230 x 8.90	K70F⁴				ST70-3	
		1963 to date	C3TZ-3111A D2TZ-3111D	A	1.231 x 7.85	K50F⁴	70.053.06			ST70-3	
2 Ton - B600, C600, F600, LN600, N600	5000# - 5500#	1967-1988	C7TZ-3111A	A	1.230 x 8.90	K70F⁴				ST70-3	
		1967-1974	C7TZ-3111A	A	1.230 x 8.90	K70F⁴				ST70-3	
		1961-1966	B7TZ-3111B C2TZ-3111B	B	1.234 x 7.43	K70D				ST70-10	
		1967-1988	C7TZ-3111A	A	1.230 x 8.90	K70F⁴				ST70-3	
		1975-1988	D6TZ-3111A	B	1.430 x 8.25	K75F⁵	70.075.06 ⁵			ST70-9	
		1989-2003	E9HZ-3111C	B	1.430 x 8.25	K76F⁶	70.076.06 ⁶			ST70-9	
		1995-1998	F5HZ-3111A	B	1.810 x 10.54	K146F				ST70-33	
		1963 to date	C3TZ-3111A D2TZ-3111D	A	1.231 x 7.85	K50F⁴	70.053.06			ST70-3	
		1967-1988	C7TZ-3111A	A	1.230 x 8.90	K70F⁴				ST70-3	
		1990 to date	E8HZ-3111A F1HZ-3111A	B	1.300 x 7.75	K72F				ST70-17	
2 ½ Ton - B700, C700, F700, LN700, N700, T700, B750, C750, F750, LN750, N750, T750	5000-5500#	1957-1966	C7TZ-3111A	A	1.230 x 8.90	K70F⁴				ST70-3	
			C2TZ-3111B	B	1.234 x 7.43	K70D				ST70-10	
		1967-1988	C7TZ-3111A	A	1.230 x 8.90	K70F⁴				ST70-3	
		1989-2003	E9HZ-3111C	B	1.430 x 8.25	K76F⁶	70.076.06 ⁶			ST70-9	
		1975-1988	D6TZ-3111A	B	1.430 x 8.25	K75F⁵	70.075.06 ⁵			ST70-9	
		1960-1983	D1HZ-3111A C2TZ-3111G	B	1.433 x 8.50	KD901R	74.901.18			ST70-9	
		1975-1988	D6HZ-3111B D6HZ-3111D	B	1.606 x 9.07	K95F⁵				ST70-13	
		1989 to date	E9HZ-3111B	B	1.606 x 9.07	K96F⁶				ST70-13	
		1960-1973	D0HZ-3111C	B	1.606 x 8.81	K970R				ST70-13	
		1960-1973	D0HZ-3111C	B	1.606 x 8.81	K970R				ST70-13	
12000# Conventional	12000#	1960-1969	C3TZ-3111B D1HZ-3111B	B	1.794 x 9.12	K901L	70.901.12			ST70-7	
		1995-1998	F5HZ-3111A	B	1.810 x 10.54	K146F				ST70-33	

FOR ALL QWIKKIT® – BUSHING “T” HANDLE WRENCHES

TOOL NO.	DESCRIPTION	TOOL NO.	DESCRIPTION
ST-100-1	Short "T" Handle Wrench	ST-100-3	Short "T" Handle Wrench
ST-100-2	Long "T" Handle Wrench	ST-100-4	Long "T" Handle Wrench
100M1-1	Replacement head	100M1-2	Replacement head

Above Wrenches will fit the bushings in most kits. The Following kits do not use wrenches: K80A, K120A, K120N, K150KG, K160A, K700T, K60U

Above Wrenches will fit the bushings in the following kits: K50F, K71F, K72F, K80G, K110G, K120G, K122V, K146E, K147E, K180E, K68Z, K69Z

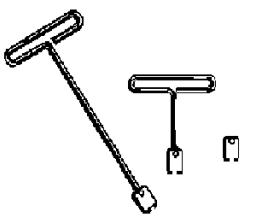

STEERING KNUCKLE KING PIN KITS

MODEL	AXLE	YEAR	OEM NO.	PIN TYPE	OEM SPEC	QWIKKIT NO. ¹	PLUSKIT NO. ²	ECONO KIT NO.	LIP SEAL/ BUSHING DRIVER INSTALLATION TOOL	AXLE SLEEVE USED WITH APE	APE CUTTER KIT USED
FORD CONT.											
800-850-880 Series	6000#	1970-1988	C7TZ-3111A	A	1.230 x 8.90	K70F⁴			ST70-3		
	7000#	1957-1969	B7TZ-3111B C2TZ-3111B	B	1.234 x 7.43	K70D			ST70-10		
	7000# Hydraulic Brakes	1970-1988	C7TZ-3111A	A	1.230 x 8.90	K70F⁴			ST70-3		
	7000-9000# Air Brakes After Series No. 40, 001	1975-1988	D6TZ-3111A	B	1.430 x 8.25	K75F⁵	70.075.06 ⁵		ST70-9		
	7000# Air Brakes	1989 to date	E9HZ-3111C	B	1.430 x 8.25	K76F⁶	70.076.06 ⁶		ST70-9		
	9000# Hydraulic Brakes	1957-1983	D1HZ-3111A C2TZ-3111G	B	1.433 x 8.50	KD901R	74.901.18		ST70-9		
	9000# Air Brakes	1975-1988	D6HZ-3111B D6HZ-3111D	B	1.606 x 9.07	K95F⁵			ST70-13		
	9000# Air Brakes	1989 to date	E9HZ-3111B	B	1.606 x 9.07	K96F⁵	50.096.06 ⁶		ST70-13		
	11000# Conventional	1957-1963	B7TZ-3111C	E	1.609 x 9.75	K125G¹²			ST70-5		
	C.P.S. 11000#	1964-1970	D0HZ-3111C	B	1.606 x 8.81	K970R			ST70-13		
	12000# Conventional	1960-1988	C3TZ-3111B D1HZ-3111B	B	1.794 x 9.12	K901L	70.901.12		ST70-7		
	C.P.S. 12000# Hydraulic Brakes	1960-1970	D0HZ-3111C	B	1.606 x 8.81	K970R			ST70-13		
	12000# Conventional	1975-1988	D6HZ-3111A	B	1.794 x 10.07	K941F⁵	70.941.06 ⁵		ST70-7	92.942.06	84.122.05
	12000# Conventional	1989 to date	E9HZ-3111A F0HZ-3111A	B	1.794 x 10.07	K942F⁵	70.942.06 ⁶		ST70-7	92.942.06	84.122.05
	14600#	1995-1998	F5HZ-3111A	B	1.810 x 10.54	K146F			ST70-33		
	16000# Air Brakes	1970-1974	D0HZ-3111E	B	1.999 x 11.04	KH901L					
	16000# Air Brakes	1975 to date	D5HZ-3111C	B	1.999 x 11.21	KH931F	78.931.06		ST70-12	92.931.12	84.931.12
	18000# Hydraulic Brakes	1960-1974	D0HZ-3111E	B	1.999 x 11.04	KH901L			ST70-12		
	18000# Air Brakes	1975 to date	D5HZ-3111C	B	1.999 x 11.21	KH931F	78.931.06		ST70-12	92.931.12	84.931.12
	20000#	1970-1974	D0HZ-3111E	B	1.999 x 11.04	KH901L			ST70-12		
	20000#	1975 to date	D5HZ-3111C	B	1.999 x 11.21	KH931F	78.931.06		ST70-12	92.931.12	84.931.12
900-950 Series	7000#	1960-1969	B7TZ-3111B C2TZ-3111B	B	1.234 x 7.43	K70D			ST70-4		
	7000# Hydraulic Brakes	1970-1988	C7TZ-3111A	A	1.230 x 8.90	K70F⁴			ST70-3		
	7000# 9000-10000# After Series No. 40, 001	1975-1988	D6TZ-3111A	B	1.430 x 8.25	K75F⁵	70.075.06 ⁵		ST70-9		
	7000# Air Brakes	1989 to date	E9HZ-3111C	B	1.430 x 8.25	K76F⁶	70.076.06 ⁶		ST70-9		
	9000# Hydraulic Brakes	1957-1983	D1HZ-3111A C2TZ-3111G	B	1.433 x 8.50	KD901R	74.901.18		ST70-9		

MODEL	AXLE	YEAR	OEM NO.	PIN TYPE	OEM SPEC	QWIKKIT NO. ¹	PLUSKIT NO. ²	ECONO KIT NO.	LIP SEAL/ BUSHING DRIVER INSTALLATION TOOL	AXLE SLEEVE USED WITH APE	APE CUTTER KIT USED
FORD CONT.											
900-950 Series	9000# Air Brakes	1975-1988	D6HZ-3111B D6HZ-3111D	B	1.606 x 9.07	K95F⁵			ST70-13		
	9000# Air Brakes	1989 to date	E9HZ-3111B	B	1.606 x 9.07	K96F⁵			ST70-13		
	11000# Conventional	1957-1963	B7TZ-3111C	E	1.609 x 9.75	K125G¹²			ST70-5		
	C.P.S. 11000#	1964-1970	D0HZ-3111C	B	1.606 x 8.81	K970R			ST70-13		
	12000# Conventional Hydraulic Brakes	1960-1988	C3TZ-3111B D1HZ-3111B	B	1.794 x 9.12	K901L	70.901.12		ST70-7		
	C.P.S. 12000#	1960-1973	D0HZ-3111C	B	1.606 x 8.81	K970R			ST70-13		
	12000# Conventional	1975-1988	D6HZ-3111A	B	1.794 x 10.07	K941F⁵	70.941.06 ⁵		ST70-7	92.942.06	84.122.05
	12000# Conventional	1989 to date	E9HZ-3111A F0HZ-3111A	B	1.794 x 10.07	K942F⁵	70.942.06 ⁶		ST70-7	92.942.06	84.122.05
	12000# ALUMINUM	1978-1988	D8HZ-3111A	B	1.794 x 10.07	K941FA⁵			ST70-7		
	12000# ALUMINUM	1989-	F6HZ-3111BB	B	1.794 x 10.07	K942FA⁶			ST70-7		
	14600#	1995-1998	F5HZ-3111A	B	1.810 x 10.54	K146F			ST70-33		
	16000# Air Brakes	1970-1974	D0HZ-3111E	B	1.999 x 11.04	KH901L			ST70-12		
	16000# Air Brakes	1975 to date	D5HZ-3111C	B	1.999 x 11.21	KH931F	78.931.06		ST70-12	92.931.12	84.931.12
	18000# Hydraulic Brakes	1960-1974	D0HZ-3111E	B	1.999 x 11.04	KH901L			ST70-12		
	18000# Air Brakes	1975 to date	D5HZ-3111C	B	1.999 x 11.21	KH931F	78.931.06		ST70-12	92.931.12	84.931.12
	20000#	1970-1974	D0HZ-3111E	B	1.999 x 11.04	KH901L			ST70-12		
	20000#	1975 to date	D5HZ-3111C	B	1.999 x 11.21	KH931F	78.931.06		ST70-12	92.931.12	84.931.12









FREIGHTLINER (SEE ROCKWELL / MERITOR, SPICER / DANA / EATON)

FWD (SEE ROCKWELL / MERITOR, SPICER / DANA / EATON)

GMC

P1500		1960-1965	3927942	A	1.109 x 6.34	K51G			ST70-14		
G1500		1966-1967	3854744	A	1.109 x 6.34	K51G			ST70-14		
P2500		1960-1965	3927942	A	1.109 x 6.34	K51G			ST70-14		
		1966-1967	3854744	A	1.109 x 6.34	K51G			ST70-14		
C3500 - Heavy Duty Pickup		1991-	15665666	A	1.179 x 6.35	K56G	70.056.07		ST70-4	91.056.07	84.056.07
3500 Series - Conventional	5000# (F-050)	1963-1966	3927942	A	1.109 x 6.34	K51G			ST70-14		
P3500	5000# (F-050)	1965-1967	3854744	A	1.109 x 6.34	K51G			ST70-14		
	5000#	1986 to date	15522020 88911968 88911987	A	1.179 x 6.35	K56G	70.056.07		ST70-4	91.056.07	84.056.07

PIN TYPE CHART:

	A – SINGLE LOCK FLAT		E – TAPERED THREADED		H – NO LOCK FLATS
	B – DOUBLE LOCK FLAT		F – TAPERED		J – SINGLE STEP
	C – SAME SIDE LOCK FLATS		G – STEP THREADED		

1. STEMCO Kaiser QwikKit® feature patented spiral steel bushings. 2. STEMCO Kaiser PlusKit® feature pre-sized steel back bronze bushings. 3. Kit has composite bushings. 4. Modify spindles to receive end plates. 5. Bolt on cap. 6. Threaded cap. 7. Length of STEMCO Kaiser pin is 9 3/4". 8. STEMCO Kaiser pin is longer than OEM. 9. Torque Spec. for king pin nut 230 ft/lbs. 10. Torque Spec. for king pin nut is 300 ft/lbs. 11. Torque Spec. for king pin nut is 406 ft/lbs. 12. Torque Spec. for king pin nut is 350/475 ft/lbs. 13. Includes end caps. 14. Torque Spec. for knuckle attachment bolts is 170-200 ft/lbs. 15. Kit uses special removal tool ST90-1.

FOR ALL QWIKKIT® – BUSHING "T" HANDLE WRENCHES

TOOL NO.	DESCRIPTION	TOOL NO.	DESCRIPTION
ST-100-1	Short "T" Handle Wrench	ST-100-3	Short "T" Handle Wrench
ST-100-2	Long "T" Handle Wrench	ST-100-4	Long "T" Handle Wrench
100M1-1	Replacement head	100M1-2	Replacement head

Above Wrenches will fit the bushings in most kits. The Following kits do not use wrenches: K80A, K120A, K120N, K150KG, K160A, K700T, K60U

Above Wrenches will fit the bushings in the following kits: K50F, K71F, K72F, K80G, K110G, K120G, K122V, K146E, K147E, K180E, K68Z, K69Z

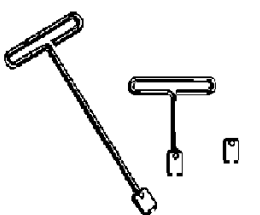

STEERING KNUCKLE KING PIN KITS

MODEL	AXLE	YEAR	OEM NO.	PIN TYPE	OEM SPEC	QWIKKIT NO. ¹	PLUSKIT NO. ²	ECONO KIT NO.	LIP SEAL/ BUSHING DRIVER INSTALLATION TOOL	AXLE SLEEVE USED WITH APE	APE CUTTER KIT USED	
GMC CONT.												
4000 Series	5000# (F-050, F-055)	1963-1966	3927942	A	1.109 x 6.34	K51G			ST70-14			
	7000# (F-070)	1963-1966	3838390 3927943	A	1.249 x 7.87	K70G	70.070.07		ST70-1			
4500 Series	5000# (F-055)	1967-1970	3927942	A	1.109 x 6.34	K51G			ST70-14			
	5000# (F-050)	1967-1972	3854744	A	1.109 x 6.34	K51G			ST70-14			
All other 5000 Series	5000# (F-050, F-055)	1967-1970	3927942	A	1.109 x 6.34	K51G			ST70-14			
	7000# (F-070)	1963-1966	3838390 3927943	A	1.249 x 7.87	K70G	70.070.07	50.070.07	ST70-1			
All other 5500 Series	5000# (F-050)	1966-1970	3927942	A	1.109 x 6.34	K51G			ST70-14			
	5000# (F-050)	1966-1972	3854744	A	1.109 x 6.34	K51G			ST70-14			
	5000# (F-055)	1975-1990	722166	A	1.179 x 6.35	K55G	70.055.07		ST70-4	91.056.07	84.056.07	
	7000# (F-070)	1963 to date	3838390 3927943	A	1.249 x 7.87	K70G	70.070.07		ST70-1			
KODIAK - C Series	7000# (FM7)		88936119	B	1.499 x 7.15	K70R	70.070.18		ST70-28			
	8000# (FM8)		88936011	B	1.499 x 7.50	K80R	70.080.18		ST70-28			
	10000# (FM6)			B	1.794 x 10.40	K120R	70.120.18		ST70-7			
	8100# (FL1)		12540328 1561960	G	1.614 x 8.00	K80G¹¹						
	9000# 11000# (FL2) 12000# (FS7)		12540329 1561961	G	1.889 x 9.20	K110G¹¹						
	14000# (FH0) 14500# (FL3) 14600# (FSD)	1990 to date	12540330 1561962	G	1.889 x 9.62	K120G¹¹						
	16000# (FH4)		88936136	B	1.999 x 11.21	K181R	70.181.18		ST70-12	92.931.12	84.931.12	
	EFA18F3 16000#		12541348	A	1.872 x 9.96	K180E	70.180.05		ST70-23	91.180.08	84.147.05	
	6000 Series	5000# (F-050, F-055)	1973-1975	3927942	A	1.109 x 6.34	K51G			ST70-14		
		5000# (F-050, F-055)	1975-1990	722166	A	1.179 x 6.36	K55G	70.055.07		ST70-4	91.056.07	84.056.07
7000# (F-070)		1973 to date	3838390 3927943	A	1.249 x 7.87	K70G	70.070.07		ST70-1			
11000# (F-110) 12000# (F-120)		1960 to date	2264897	E	1.609 x 9.75	K125G¹²			ST70-5			
6500 Series	7000# (F-070)	1963 to date	3838390 3927943	A	1.249 x 7.87	K70G	70.070.07		ST70-1			
	11000# (F-110)	1960-1975	2264897	E	1.609 x 9.75	K125G¹²			ST70-5			
	12000# (F-120)	1963-1975	2264897	E	1.609 x 9.75	K125G¹²			ST70-5			
	12000# (F-120D)	1975 to date	8885621	B	1.745 x 9.37	K121G⁷			ST70-11			
7000 Series	11000# (F-110)	1960-1966	2264897	E	1.609 x 9.75	K125G¹²			ST70-5			
7500 Series	7000# (F-070)	1966 to date	3838390 3927943	A	1.249 x 7.87	K70G	70.070.07		ST70-1			
	11000# (F-110)	1963-1975	2264897	E	1.609 x 9.75	K125G¹²			ST70-5			
	12000# (F-120)	1963-1975	2264897	E	1.609 x 9.75	K125G¹²			ST70-5			

MODEL	AXLE	YEAR	OEM NO.	PIN TYPE	OEM SPEC	QWIKKIT NO. ¹	PLUSKIT NO. ²	ECONO KIT NO.	LIP SEAL/ BUSHING DRIVER INSTALLATION TOOL	AXLE SLEEVE USED WITH APE	APE CUTTER KIT USED
GMC CONT.											
7500 Series	12000# (F-120D)	1975 to date	8885621	B	1.745 x 9.37	K121G⁷			ST70-11		
	18000# (FL-901)	1970 to date	2452865	B	1.999 x 11.04	KH901L			ST70-12		
8500 Series	7000# (F-070)	1966 to date	3838390 3927943	A	1.249 x 7.87	K70G	70.070.07		ST70-1		
	11000# (F-110)	1963-1972	2264897	E	1.609 x 9.75	K125G¹²			ST70-5		
	12000# (F-120)	1963-1975	2264897	E	1.609 x 9.75	K125G¹²			ST70-5		
	12000# (F-120D)	1975 to date	8885621	B	1.745 x 9.38	K121G⁷			ST70-11		
9000 Series	11000# (F-110)	1960-1962	2264897	E	1.609 x 9.75	K125G¹²			ST70-5		
	9500 Series	7000# (F-070)	1966 to date	3838390 3927943	A	1.249 x 7.87	K70G	70.070.07		ST70-1	
11000# (F-110)		1963-1975	2264897	E	1.609 x 9.75	K125G¹²			ST70-5		
11000# (FE-970)		1966-1972	2442145	B	1.606 x 8.81	K970R			ST70-13		
12000# (F-120)		1963-1975	2264897	E	1.609 x 9.75	K125G¹²			ST70-5		
12000# (FE-900)		1966-1972	2264897	E	1.609 x 9.75	K125G¹²			ST70-5		
12000# (F-120D)		1975 to date	8885621	B	1.745 x 9.37	K121G⁷			ST70-11		
18000# (FL-901)		1966 to date	2452865	B	1.999 x 11.04	KH901L			ST70-12		
18000# (FL-931)			2036352	B	1.999 x 11.21	KH931L	78.931.12		ST70-12	92.931.12	84.931.12
HENDRICKSON											
FRONT STEER AXLE	AIRTEK SOFTEK STEERTEK 64905-004		60961-009 60961-039 60961-040 00063311 LT SIDE 00063312 RT SIDE 00063313 BT SIDES						ST70-32		
			AIRTEK NXT SOFTEK NXT STEERTEK NXT						ST70-32		
REAR TAG AXLES	UST		002916	A	1.810 x 10.56	K126W	70.126.23		ST70-33	91.127.23	84.122.05
	UC2, UC3, UC4 US2, US3, US4		003270 003200	H	1.810 x 9.54	K120H¹⁴			ST70-33		
	USP		001434	A	1.810 x 10.56	K127W	70.127.23		ST70-33	91.127.23	84.122.05
			006648	A	1.810 x 9.54	K131H			ST70-33		
HINO											
NA, NB, NC		2005-2008	R201478	A	1.234 x 6.78	K60R			ST70-3	91.060.18	84.060.18
ND, NE, NJ-258 A-LP	8,000#	2005-2008	R201474	B	1.499 x 7.50	K80R	70.080.18		ST70-28		
ND, NE, NJ, NV	10,000#	2005-2008	R201470	B	1.794 x 10.40	K961L	70.961.12		ST70-7	92.961.12	84.122.05
IMT / INGERSOLL											
	700214		700040	B	2.248 x 11.30	K700T	70.700.20		ST70-29	92.700.20	84.700.20

PIN TYPE CHART:

	A – SINGLE LOCK FLAT		E – TAPERED THREADED		H – NO LOCK FLATS
	B – DOUBLE LOCK FLAT		F – TAPERED		J – SINGLE STEP
	C – SAME SIDE LOCK FLATS		G – STEP THREADED		

1. STEMCO Kaiser QwikKit® feature patented spiral steel bushings. 2. STEMCO Kaiser PlusKit® feature pre-sized steel back bronze bushings. 3. Kit has composite bushings. 4. Modify spindles to receive end plates. 5. Bolt on cap. 6. Threaded cap. 7. Length of STEMCO Kaiser pin is 9 3/4". 8. STEMCO Kaiser pin is longer than OEM. 9. Torque Spec. for king pin nut 230 ft/lbs. 10. Torque Spec. for king pin nut is 300 ft/lbs. 11. Torque Spec. for king pin nut is 406 ft/lbs. 12. Torque Spec. for king pin nut is 350/475 ft/lbs. 13. Includes end caps. 14. Torque Spec. for knuckle attachment bolts is 170-200 ft/lbs. 15. Kit uses special removal tool ST90-1.

FOR ALL QWIKKIT® – BUSHING "T" HANDLE WRENCHES

TOOL NO.	DESCRIPTION	TOOL NO.	DESCRIPTION
ST-100-1	Short "T" Handle Wrench	ST-100-3	Short "T" Handle Wrench
ST-100-2	Long "T" Handle Wrench	ST-100-4	Long "T" Handle Wrench
100M1-1	Replacement head	100M1-2	Replacement head

Above Wrenches will fit the bushings in most kits. The Following kits do not use wrenches: K80A, K120A, K120N, K150KG, K160A, K700T, K60U

Above Wrenches will fit the bushings in the following kits: K50F, K71F, K72F, K80G, K110G, K120G, K122V, K146E, K147E, K180E, K68Z, K69Z

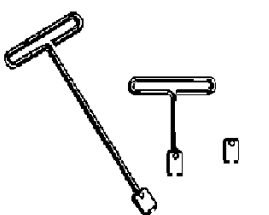

STEERING KNUCKLE KING PIN KITS

MODEL	AXLE	YEAR	OEM NO.	PIN TYPE	OEM SPEC	QWIKKIT NO. ¹	PLUSKIT NO. ²	ECONO KIT NO.	LIP SEAL/ BUSHING DRIVER INSTALLATION TOOL	AXLE SLEEVE USED WITH APE	APE CUTTER KIT USED
INTERNATIONAL / NAVISTAR											
7500# FA-65		1957-1966	61556R91	A	1.234 x 7.65	K98I	70.098.09	50.098.09	ST70-10		
8200# FA-71		1975-1988	473695C91	A	1.359 x 7.96	K101I	70.101.09	50.101.09	ST70-2	91.101.09	84.103.19
8200# FA-73		1975-1988	473695C91	A	1.359 x 7.96	K101I	70.101.09	50.101.09	ST70-2	91.101.09	84.103.19
8200# FA-74		1975-1988	473695C91	A	1.359 x 7.96	K101I	70.101.09	50.101.09	ST70-2	91.101.09	84.103.19
7500# FA-80		1950-1968	61556R91	A	1.234 x 7.65	K98I	70.098.09	50.098.09	ST70-10		
7500# FA-91		1960-1968	61556R91	A	1.234 x 7.65	K98I	70.098.09	50.098.09	ST70-10		
7500# FA-98		1950-1975	61556R91	A	1.234 x 7.65	K98I	70.098.09	50.098.09	ST70-10		
7500# FA-99		1957-1975	61556R91	A	1.234 x 7.65	K98I	70.098.09	50.098.09	ST70-10		
9000# FA-100		1950-1968	303136C92	B	1.433 x 8.50	KD901R	74.901.18		ST70-9		
7500# FA-101		1962-1975	61556R91	A	1.234 x 7.65	K98I	70.098.09	50.098.09	ST70-10		
8200# FA-101 FA-104		1975-1988	473695C91 1648204C91	A	1.359 x 7.96	K101I	70.101.09	50.101.09	ST70-2	91.101.09	84.103.19
8200# FA-101 FA-104		1989 to date	1660271C92	B	1.359 x 7.96	K102I	70.102.09		ST70-2	92.102.09	84.103.19
9000# FA-102		1963-1968	303136C92	B	1.433 x 8.50	KD901R	74.901.18		ST70-9		
7500# FA-103			473695C91	A	1.359 x 7.96	K101I	70.101.09	50.101.09	ST70-2	91.101.09	84.103.19
9000# FA-105		1955-1975	303136C92	B	1.433 x 8.50	KD901R	74.901.18		ST70-9		
9000# FA-109		1970-1981	408547C91 408547C93 472093C91	B	1.484 x 8.85	K109I					
9000# FA-109		1981 to date	493092C91 493095C92	A	1.484 x 8.85	K108I					
12000# FA-110		1950-1968	155932R92 303137C92 69576R92	E	1.609 x 9.75	K125G¹²			ST70-5		
12000# FA-112		1960-1975	229265R91 303138C92	B	1.606 x 8.81	K970R			ST70-13		
12000# FA-113		1960-1975	229265R91 303138C92	B	1.606 x 8.81	K970R			ST70-13		
12000# FA-115		1955-1968	155932R92 303137C92 69576R92	E	1.609 x 9.75	K125G¹²			ST70-5		
12000# FA-118		1981 to date	399942C93 588808C91 1658934C91	B	1.609 x 9.65	K140I	70.140.09		ST70-5	92.140.09	84.120.05
12000# FA-127		1981 to date	588808C91 1658934C91 399942C93	B	1.609 x 9.65	K140I	70.140.09		ST70-5	92.140.09	84.120.05
18000# FA-136		1963-1975	303140C92	B	1.999 x 11.04	KH901L			ST70-12		
12000# FA-139		1975-1981	472094C91 491611C93 493094C93	A	1.609 x 9.65	K139I	70.139.09		ST70-5		
12000# FA-139		1981 to date	588808C91 1658934C91 399942C93	B	1.609 x 9.65	K140I	70.140.09		ST70-5	92.140.09	84.120.05

MODEL	AXLE	YEAR	OEM NO.	PIN TYPE	OEM SPEC	QWIKKIT NO. ¹	PLUSKIT NO. ²	ECONO KIT NO.	LIP SEAL/ BUSHING DRIVER INSTALLATION TOOL	AXLE SLEEVE USED WITH APE	APE CUTTER KIT USED
INTERNATIONAL / NAVISTAR CONT.											
12000# FA-201		1960-1972	303139C92 870148R92	B	1.794 x 9.12	K901L	70.901.12		ST70-7		
9000# FA-208		1960-1975	303136C92	B	1.433 x 8.50	KD901R	74.901.18		ST70-9		
9000# FA-209		1960-1975	303136C92	B	1.433 x 8.50	KD901R	74.901.18		ST70-9		
12000# FA-211		1960-1973	303139C92 870148R92	B	1.794 x 9.12	K901L	70.901.12		ST70-7		
12000# FA-212		1960-1973	303139C92 870148R92	B	1.794 x 9.12	K901L	70.901.12		ST70-7		
12000# FA-215 FA-216, FA-217		1960-1973	303139C92 870148R92	B	1.794 x 9.12	K901L	70.901.12		ST70-7		
12000# FA-218		1960-1973	303139C92 870148R92	B	1.794 x 9.12	K901L	70.901.12		ST70-7		
12000# FA-219		1963-1973	303139C92 870148R92	B	1.794 x 9.12	K901L	70.901.12		ST70-7		
12000# FA-228		1973 to date	452344C91	B	1.794 x 10.39	K921L	70.921.12		ST70-7		
16000# FA-231			474520C91	B	1.999 x 11.21	KH931L	78.931.12		ST70-12	92.931.12	84.931.12
18000# FA-232			474520C91	B	1.999 x 11.21	KH931L	78.931.12		ST70-12	92.931.12	84.931.12
9000# FA-309		1975-1981	470752C91 493095C91	A	1.609 x 9.15	K309I	70.309.09		ST70-5		
9000# FA-309		1981 to date	586806C91	B	1.609 x 9.15	K310I	70.310.09		ST70-5		
10800# FA-329		1975-1981	472094C91 491611C92 493094C92 493094C93	A	1.609 x 9.65	K139I	70.139.09		ST70-5		
12000# FA-329		1981 to date	588808C91 1658934C91 399942C93 1655421C91	B	1.609 x 9.65	K140I	70.140.09		ST70-5	92.140.09	84.120.05
12000# FA-339		1975-1981	472094C91 491611C92 493094C92 493094C93	A	1.609 x 9.65	K139I	70.139.09		ST70-5		
12000# FA-339 FA-337 FA-343		1981 to date	588808C91 1658934C91 399942C93	B	1.609 x 9.65	K140I	70.140.09		ST70-5	92.140.09	84.120.05
10800# FA-341 Aluminum Axle			472094C91 491611C92 493094C92 493094C93	A	1.609 x 9.65	K139I	70.139.09		ST70-5		
12000# FA-342 FA-343		1981 to date	588808C91 1658934C91 399942C93 493094C93	B	1.609 x 9.65	K140I	70.140.09		ST70-5	92.140.09	84.120.05
5000# I-050			473695C91	A	1.359 x 7.96	K101I	70.101.09	50.101.09	ST70-2	91.101.09	84.103.19
6000# I-060			473695C91	A	1.359 x 7.96	K101I	70.101.09	50.101.09	ST70-2	91.101.09	84.103.19
7500# I-075			473695C91	A	1.359 x 7.96	K101I	70.101.09	50.101.09	ST70-2	91.101.09	84.103.19
8000# I-80S, I-80SG, O2-ADB, O2-ADV			1660271C92	B	1.359 x 7.96	K102I	70.102.09		ST70-2	92.102.09	84.103.19
8000# O2-AEM, O2-AHA			3573204C91	C	1.359 x 7.97	K103S	70.103.19		ST70-2	93.103.19	84.103.19
9000# I-090		Before Aug. 1981	470752C91 493095C91	A	1.609 x 9.15	K309I	70.309.09		ST70-5		

PIN TYPE CHART:

	A – SINGLE LOCK FLAT		C – SAME SIDE LOCK FLATS		G – STEP THREADED
	B – DOUBLE LOCK FLAT		E – TAPERED THREADED		H – NO LOCK FLATS
	F – TAPERED		J – SINGLE STEP		

1. STEMCO Kaiser QwikKit® feature patented spiral steel bushings. 2. STEMCO Kaiser PlusKit® feature pre-sized steel back bronze bushings. 3. Kit has composite bushings. 4. Modify spindles to receive end plates. 5. Bolt on cap. 6. Threaded cap. 7. Length of STEMCO Kaiser pin is 9 3/4". 8. STEMCO Kaiser pin is longer than OEM. 9. Torque Spec. for king pin nut 230 ft/lbs. 10. Torque Spec. for king pin nut is 300 ft/lbs. 11. Torque Spec. for king pin nut is 406 ft/lbs. 12. Torque Spec. for king pin nut is 350/475 ft/lbs. 13. Includes end caps. 14. Torque Spec. for knuckle attachment bolts is 170-200 ft/lbs. 15. Kit uses special removal tool ST90-1.

FOR ALL QWIKKIT® – BUSHING "T" HANDLE WRENCHES

TOOL NO.	DESCRIPTION	TOOL NO.	DESCRIPTION
ST-100-1	Short "T" Handle Wrench	ST-100-3	Short "T" Handle Wrench
ST-100-2	Long "T" Handle Wrench	ST-100-4	Long "T" Handle Wrench
100M1-1	Replacement head	100M1-2	Replacement head

Above Wrenches will fit the bushings in most kits. The Following kits do not use wrenches: K80A, K120A, K120N, K150KG, K160A, K700T, K60U

Above Wrenches will fit the bushings in the following kits: K50F, K71F, K72F, K80G, K110G, K120G, K122V, K146E, K147E, K180E, K68Z, K69Z

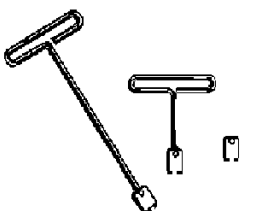

STEERING KNUCKLE KING PIN KITS

MODEL	AXLE	YEAR	OEM NO.	PIN TYPE	OEM SPEC	QWIKKIT NO. ¹	PLUSKIT NO. ²	ECONO KIT NO.	LIP SEAL/ BUSHING DRIVER INSTALLATION TOOL	AXLE SLEEVE USED WITH APE	APE CUTTER KIT USED
INTERNATIONAL / NAVISTAR CONT.											
9000# I-090		After Aug. 1981	586806C91	B	1.609 x 9.15	K310I	70.310.09		ST70-5		
10000# I-100S I-100SG, 02-ADC			1688411C92	B	1.921 x 9.87	K120I⁸	70.120.09 ⁸ 70.120.99 ^{3,8}		ST70-19	92.120.09	84.147.05
10000# I-100W 02-AER			329022	B	2.046 x 10.12	K141S⁹	70.141.19 ⁹		ST70-24		
10800# I-108 All except code 02309			588808C91 399942C93	B	1.609 x 9.65	K140I	70.140.09		ST70-5	92.140.09	84.120.05
10800# I-108 For code 02309			586806C91	B	1.609 x 9.15	K310I	70.310.09		ST70-5		
12000# I-120 All except code 02309			588808C91 399942C93	B	1.609 x 9.65	K140I	70.140.09		ST70-5	92.140.09	84.120.05
12000# I-120 For code 02309			586806C91	B	1.609 x 9.15	K310I	70.310.09		ST70-5		
12000# I-120S I-120SG, 02-ADD 02-ADG, 02-ADP		1989 to date	1668411C91 1659688C91 1659686C91 1659687C91	B	1.921 x 9.87	K120I⁸	70.120.09 ⁸ 70.120.99 ^{3,8}		ST70-19	92.120.09	84.147.05
13200# I-132 I-132S			586806C91	B	1.609 x 9.65	K140I	70.140.09		ST70-5	92.140.09	84.120.05
14000# I-140S 02-ADE		1990 to date	1668412C91	B	2.046 x 10.12	K141S⁹	70.141.19 ⁹		ST70-24		
With Meritor Axles:											
12000# FE-900		1950-1962	303137C92 69576R92 155932R92	E	1.609 x 9.75	K125G¹²			ST70-5		
12000# FE-970		1964-1968	229265R91 303138C92	B	1.606 x 8.81	K970R			ST70-13		
12000# FF-921		1972 to date	452344C91	B	1.794 x 10.39	K921L	70.921.12		ST70-7		
18000# FL-901			303140C92 870148R92	B	1.999 x 10.90	KH901L			ST70-12		
12000# FE-971			577684C91	B	1.607 x 9.37	K971R			ST70-13		
12000# FF-931 FF-941			549800C91	B	1.794 x 10.40	K931L	70.931.12		ST70-7	92.961.12	84.122.05
12000# FF-961 02-ARV, 02-ARA 02-ARW			2505492C91	B	1.794 x 10.40	K961L	70.961.12		ST70-7	92.961.12	84.122.05
12000# 02-AED 02-AEG				A	1.794 x 9.05	K122E	70.122.05		ST70-7	91.122.05	84.122.05
18000# FL-931 FL-941			474520C91	B	1.999 x 11.21	KH931L	78.931.12		ST70-12	92.931.12	84.931.12
18000# 02-ARU			2505495C91	B	1.999 x 11.21	K180R	70.180.18		ST70-12	92.180.18	84.931.12
12000# FF-981 02-ARK, 02-ARL 02-ASB, 02-ASD			2500542C91	B	1.794 x 8.87	K981R	70.981.18		ST70-7	92.961.12	84.122.05
ISUZU											
FTR			12540329	G	1.889 x 9.20	K110G					
NPR		1990-1998	5-87830978-2 94058104	A	1.181 x 7.38	K68Z	70.068.26		ST70-37	91.068.26	84.056.07

PIN TYPE CHART:

	A – SINGLE LOCK FLAT		E – TAPERED THREADED		H – NO LOCK FLATS
	B – DOUBLE LOCK FLAT		F – TAPERED		J – SINGLE STEP
	C – SAME SIDE LOCK FLATS		G – STEP THREADED		

1. STEMCO Kaiser QwikKit® feature patented spiral steel bushings. 2. STEMCO Kaiser PlusKit® feature pre-sized steel back bronze bushings. 3. Kit has composite bushings. 4. Modify spindles to receive end plates. 5. Bolt on cap. 6. Threaded cap. 7. Length of STEMCO Kaiser pin is 9 3/4". 8. STEMCO Kaiser pin is longer than OEM. 9. Torque Spec. for king pin nut is 230 ft/lbs. 10. Torque Spec. for king pin nut is 300 ft/lbs. 11. Torque Spec. for king pin nut is 406 ft/lbs. 12. Torque Spec. for king pin nut is 350/475 ft/lbs. 13. Includes end caps. 14. Torque Spec. for knuckle attachment bolts is 170-200 ft/lbs. 15. Kit uses special removal tool ST90-1.

MODEL	AXLE	YEAR	OEM NO.	PIN TYPE	OEM SPEC	QWIKKIT NO. ¹	PLUSKIT NO. ²	ECONO KIT NO.	LIP SEAL/ BUSHING DRIVER INSTALLATION TOOL	AXLE SLEEVE USED WITH APE	APE CUTTER KIT USED
ISUZU CONT.											
NPR		1998-present	5-87831608-1 97723802 98441181 5-87832211-1	A	1.181 x 7.38	K69Z	70.069.26		ST70-37	91.068.26	84.056.07
KENWORTH (SEE MERITOR, SPICER/DANA/EATON AXLES)											
KGI											
	15000# KGS150		579-1044	A	1.999 x 11.32	K150KG			ST70-26	91.150.07	84.931.12
	23000# KGS230		KA531	A	2.249 x 10.60	K230KG	70.230.07		ST70-29	94.230.07	84.700.20
KIMBLE MIXER											
			T41-12001-71	C	1.872 x 9.05	K149E			ST70-23	93.147.05	84.147.05
LINK											
	12000# DuraLift & Model 9000		84001930	A	1.794 x 9.05	K123K			ST70-7		
	13200# DuraLift & Model 9000		84001931	A	1.794 x 9.05	K132K			ST70-7	91.132.11	84.122.05
MACK											
Midliner MS-CS	7500# 9500#		50.00336305	A	1.377 x 7.00	K75M					
DM, RM, DUMP, MIXER, CONSTRUCTION, REFUSE	10000# FA-507 FA-5071		301SQ46A	F	1.500 x 7.40	K535M⁴					
	10000# FA-512		301SQ46A	F	1.500 x 7.40	K535M⁴					
	10000# FA-514 FA-5141		301SQ46A	F	1.500 x 7.40	K535M⁴					
	10000# FA-517		301SQ46A	F	1.500 x 7.40	K535M⁴					
	12000# FA-522 FA-5221	1963 to date	301SQ47CPI 301SQ47D	F	1.625 x 7.46	K533M thin wall bushing	70.533.13		ST70-6		
	12000# FA-523 FA-5231	1963 to date	301SQ47CPI 301SQ47D 301SQ47E	F	1.625 x 7.46	K533M thin wall bushing	70.533.13		ST70-6		
	12000# FA-532 FA-538	1950 to date	301SQ47CPI 301SQ47D 301SQ47E	F	1.625 x 7.46	K533M thin wall bushing	70.533.13		ST70-6		
	10000# FA-535		301SQ46A	F	1.500 x 7.40	K535M⁴					
	12000# FXL12		301SQ53	E	2.360 x 8.92	K536M¹⁵					
	14600# FXL14.6		301SQ53	E	2.360 x 8.92	K536M¹⁵					
	18000# FA-602 FA-604		2055Q12	B	1.999 x 10.90	KH901L			ST70-12		
	18000# FA-616 FA-617		301SQ52	F	2.125 x 8.75	K616M	70.616.13		ST70-18		
	18000# FXL18		301SQ53	E	2.360 x 8.92	K536M¹⁵					
	20000# FA-616 FA-617		301SQ52	F	2.125 x 8.75	K616M	70.616.13		ST70-18		

FOR ALL QWIKKIT® – BUSHING "T" HANDLE WRENCHES

TOOL NO.	DESCRIPTION	TOOL NO.	DESCRIPTION
ST-100-1	Short "T" Handle Wrench	ST-100-3	Short "T" Handle Wrench
ST-100-2	Long "T" Handle Wrench	ST-100-4	Long "T" Handle Wrench
100M1-1	Replacement head	100M1-2	Replacement head

Above Wrenches will fit the bushings in most kits. The Following kits do not use wrenches: K80A, K120A, K120N, K150KG, K160A, K700T, K60U

Above Wrenches will fit the bushings in the following kits: K50F, K71F, K72F, K80G, K110G, K120G, K122V, K146E, K147E, K180E, K68Z, K69Z

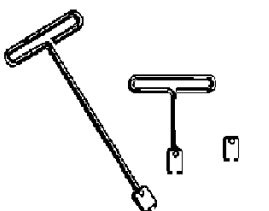

STEERING KNUCKLE KING PIN KITS

MODEL	AXLE	YEAR	OEM NO.	PIN TYPE	OEM SPEC	QWIKKIT NO. ¹	PLUSKIT NO. ²	ECONO KIT NO.	LIP SEAL/ BUSHING DRIVER INSTALLATION TOOL	AXLE SLEEVE USED WITH APE	APE CUTTER KIT USED
MACK CONT.											
DM, RM, DUMP, MIXER, CONSTRUCTION, REFUSE	20000# FXL20		301SQ53	E	2.360 x 8.92	K536M¹⁵					
	23000# FXL23		301SQ53	E	2.360 x 8.92	K536M¹⁵					
	24000# FA-616 FA-617		301SQ52	F	2.125 x 8.75	K616M	70.616.13		ST70-18		
With Meritor Axles:	12000# FE-900	1960-1966	205SQ11	E	1.609 x 9.75	K125G¹²			ST70-5		
	12000# FF-921	1972 to date	205SQ15	B	1.794 x 10.39	K921L	70.921.12		ST70-7		
	18000# FL-901		205SQ12	B	1.999 x 11.04	KH901L			ST70-12		
MAN											
	V8 65C-02	1993	81.44205-6013 6313078	J	1.969 x 8.77	K120N			ST70-27		
MCI											
MC-7, MC-8, MC-9	12000#		121	E	1.794 x 10.68	K170G¹²					
	15000# 16000#		2254366 IC-2-40	E	1.794 x 10.68	K170G¹²					
	13200# FF-941 FF-961			B	1.794 x 10.40	K961L	70.961.12		ST70-7	92.961.12	84.122.05
MC-12	14600# FG-931, FG-933, FG-941, FG-943, FG-952		IJ-2-54	B	1.794 x 10.40	KG931R	77.931.18		ST70-7	92.931.12	84.122.05
102DL3	16000# 20000# FH-946		01-01-1017 01-01-1079	B	1.794 x 9.19	KH946R	78.946.18		ST70-7	92.946.18	84.122.05
G COACH	16000# 1-160S			B	2.046 x 11.00	K161S			ST70-24		
McNELIUS MTM											
			188033	A	1.810 x 10.56	K126W	70.126.23		ST70-33	91.127.23	84.122.05
MERITOR (NON-DRIVING FRONT STEERING AXLES)											
	12000# 16612, 16613, 16616		123, 144, 152, 186	E	1.607 x 9.75	K125G¹²			ST70-5		
	12000# 16930, 16931		121	E	1.794 x 10.68	K170G¹²					
	14600# 17100, 17101, 17111, 17801		1309, 1310, 1319	B	1.794 x 10.40	KG931R	77.931.18		ST70-7	92.931.18	84.122.05
	5000# FA941			A	1.179 x 6.36	K56G	70.056.07		ST70-4	91.056.07	84.056.07
	7000# FC-901 FC-902, FC-903		143, 155	B	1.234 x 7.43	K70D			ST70-10		
	FC-921		1314, 1320	B	1.234 x 7.43	K71D			ST70-10		
	8000# FC-941		1318	B	1.500 x 8.93	K941R	70.941.18		ST70-28		
	9000# FD-901 FD-902, FD-903	1955 to date	138, 142, 154	B	1.434 x 8.50	KD901R	74.901.18		ST70-9		
	10000# FD-961 FD-965		1315, 1470, 1471	B	1.794 x 10.40	K961L	70.961.12		ST70-7	92.961.12	84.122.05
	11000# FE-900 FE-903, FE-910		123, 144	E	1.607 x 9.75	K125G¹²			ST70-5		

PIN TYPE CHART:

	A – SINGLE LOCK FLAT		E – TAPERED THREADED		H – NO LOCK FLATS
	B – DOUBLE LOCK FLAT		F – TAPERED		J – SINGLE STEP
	C – SAME SIDE LOCK FLATS		G – STEP THREADED		

1. STEMCO Kaiser QwikKit® feature patented spiral steel bushings. 2. STEMCO Kaiser PlusKit® feature pre-sized steel back bronze bushings. 3. Kit has composite bushings. 4. Modify spindles to receive end plates. 5. Bolt on cap. 6. Threaded cap. 7. Length of STEMCO Kaiser pin is 9 3/4". 8. STEMCO Kaiser pin is longer than OEM. 9. Torque Spec. for king pin nut 230 ft/lbs. 10. Torque Spec. for king pin nut is 300 ft/lbs. 11. Torque Spec. for king pin nut is 406 ft/lbs. 12. Torque Spec. for king pin nut is 350/475 ft/lbs. 13. Includes end caps. 14. Torque Spec. for knuckle attachment bolts is 170-200 ft/lbs. 15. Kit uses special removal tool ST90-1.

MODEL	AXLE	YEAR	OEM NO.	PIN TYPE	OEM SPEC	QWIKKIT NO. ¹	PLUSKIT NO. ²	ECONO KIT NO.	LIP SEAL/ BUSHING DRIVER INSTALLATION TOOL	AXLE SLEEVE USED WITH APE	APE CUTTER KIT USED
MERITOR (NON-DRIVING FRONT STEERING AXLES) CONT.											
	12000# FE-970 (Straight Pin)		156, 157	B	1.606 x 8.81	K970R				ST70-13	
	12000# FF-971		1300	B	1.609 x 9.37	K971R				ST70-13	
	12000# FF-901, FF-903		167, 172	B	1.794 x 9.12	K901L	70.901.12			ST70-7	
	12000# FF-921, FF-923		193, 199	B	1.794 x 10.39	K921L	70.921.12			ST70-1	
	16000# FH-901		168, 170	B	1.999 x 11.04	KH901L				ST70-12	
	18000# FL-901		168, 170	B	1.999 x 11.04	KH901L				ST70-12	
	12000# FF-930		121	E	1.794 x 10.68	K170G¹²					
	12000# FF-931 FF-932, FF-933 FF-934		195, 1307	B	1.794 x 10.40	K931L	70.931.12			ST70-7	92.961.12 84.122.05
1-599 Series	13200# FF-941 FF-942, FF-943 FF-944, FF-945		195, 1307	B	1.794 x 10.40	K931L	70.931.12			ST70-7	92.961.12 84.122.05
600 Series	13200# FF-941 FF-942, FF-943 FF-944, FF-945		1315, 1470	B	1.794 x 10.40	K961L	70.961.12			ST70-7	92.961.12 84.122.05
	FF-946		R201473	B	1.794 x 10.40	K120R	70.120.18			ST70-7	
	13200# FF-961 FF-962, FF-966 FF-967, FC-965		1315, 1470	B	1.794 x 10.40	K961L	70.961.12			ST70-7	92.961.12 84.122.05
	12000# FF-981 FF-982, FF-983 FF-984, FF-986 FF-987		1419, 1472	B	1.794 x 8.87	K981R	70.981.18			ST70-7	92.961.12 84.122.05
	14600# FG-931 FG-933, FG-941 FG-943, FG-952		1309, 1310 1319, 1471	B	1.794 x 10.40	KG931R	77.931.18			ST70-7	92.931.18 84.122.05
	16000# FH-941 20000# FH-945 FH-946		1424 1420	B	1.794 x 9.19	KH946R	78.946.18			ST70-7	92.946.18 84.122.05
	18000# FL-931 FL-933, FL-941 FL-943, FH-951		198, 1312	B	1.999 x 11.22	KH931L	78.931.12			ST70-12	92.931.12 84.931.12
	6000# MFS-06		R201478	A	1.234 x 6.78	K60R				ST70-3	91.060.18 84.060.18
	7000# MFS-07		R201479, R201483	B	1.499 x 7.15	K70R	70.070.18			ST70-28	
	8000# MFS-08		R201474	B	1.499 x 7.50	K80R	70.080.18			ST70-28	
	10000# MFS-10		R201470	B	1.794 x 10.40	K961L	70.961.12			ST70-7	92.961.12 84.122.05
	12000# MFS-12122A MFS-12143A MFS-12153A		R201315 R201470	B	1.794 x 10.40	K961L	70.961.12			ST70-7	92.961.12 84.122.05
	12000# MFS-12122D MFS-12143D MFS-12144D		R201419 R201472	B	1.794 x 8.87	K981R	70.981.18			ST70-7	92.961.12 84.122.05

FOR ALL QWIKKIT® – BUSHING “T” HANDLE WRENCHES

TOOL NO.	DESCRIPTION	TOOL NO.	DESCRIPTION
ST-100-1	Short "T" Handle Wrench	ST-100-3	Short "T" Handle Wrench
ST-100-2	Long "T" Handle Wrench	ST-100-4	Long "T" Handle Wrench
100M1-1	Replacement head	100M1-2	Replacement head

Above Wrenches will fit the bushings in most kits. The Following kits do not use wrenches: K80A, K120A, K120N, K150KG, K160A, K700T, K60U

Above Wrenches will fit the bushings in the following kits: K50F, K71F, K72F, K80G, K110G, K120G, K122V, K146E, K147E, K180E, K68Z, K69Z

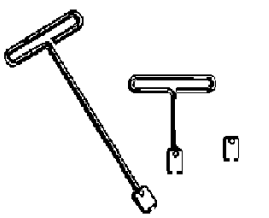









STEERING KNUCKLE KING PIN KITS

MODEL	AXLE	YEAR	OEM NO.	PIN TYPE	OEM SPEC	QWIKKIT NO. ¹	PLUSKIT NO. ²	ECONO KIT NO.	LIP SEAL/ BUSHING DRIVER INSTALLATION TOOL	AXLE SLEEVE USED WITH APE	APE CUTTER KIT USED
MERITOR (NON-DRIVING FRONT STEERING AXLES) CONT.											
12000# MFS-12144A MFS-12155A			R201473	B	1.794 x 10.40	K120R	70.120.18		ST70-7		
12000# MFS-12			R201608	B	1.794 x 9.02	K131R			ST70-7		
13000# MFS-13122D MFS-13143D MFS-13144D			R201419 R201472	B	1.794 x 8.87	K981R	70.981.18		ST70-7	92.961.12	84.122.05
13000# MFS-131015 MFS-13143A MFS-13144A			R201471	B	1.794 x 10.40	KG931R	77.931.18		ST70-7	92.931.18	84.122.05
13000# MFS-13			R201608	B	1.794 x 9.02	K131R			ST70-7		
13000# MFS-13			R201609	B	1.794 x 9.02	K130R			ST70-7		
14000# MFS-141015 MFS-14143A MFS-14153A			R201471	B	1.794 x 10.40	KG931R	77.931.18		ST70-7	92.931.18	84.122.05
14000# MFS-14			R201609	B	1.794 x 9.02	K130R			ST70-7		
16000# MFS-161015 MFS-16122A MFS-16143A			R201475	B	1.999 x 11.21	K180R	70.180.18		ST70-12	92.180.18	84.931.12
16000# MFS-16133A			R201476	B	1.999 x 11.21	K181R	70.181.18		ST70-12	92.931.12	84.931.12
18000# MFS-18133ANN			R201476	B	1.999 x 11.21	K181R	70.181.18		ST70-12	92.931.12	84.931.12
18000# MFS-18133ANK			R201482	B	1.999 x 10.79	K200R			ST70-12		
18000# MFS-18143A			R201475	B	1.999 x 11.21	K180R	70.180.18		ST70-12	92.180.18	84.931.12
20000# MFS-20133ANN			R201476	B	1.999 x 11.21	K181R	70.181.18		ST70-12	92.931.12	84.931.12
20000# MFS-20133ANK			R201482	B	1.999 x 10.79	K200R			ST70-12		
20000# MFS-20142A			R201477	B	1.999 x 11.21	KH931L	78.931.12		ST70-12	92.931.12	84.931.12
MITSUBISHI											
			MK703748	A	1.101 x 7.10	K60U			ST70-34		
NEW FLYER											
MAN			6313078	J	1.969 x 8.77	K120N			ST70-27		
PETERBILT (SEE MERITOR, SPICER / DANA / EATON)											

MODEL	AXLE	YEAR	OEM NO.	PIN TYPE	OEM SPEC	QWIKKIT NO. ¹	PLUSKIT NO. ²	ECONO KIT NO.	LIP SEAL/ BUSHING DRIVER INSTALLATION TOOL	AXLE SLEEVE USED WITH APE	APE CUTTER KIT USED
RIDEWELL											
	RSS-232-8K		1660170	B	1.500 x 8.93	K941R	70.941.18		ST70-28		
	RSS-232LM, MM, HM		1660106	B	1.794 x 10.40	KG931R	77.931.18		ST70-7	91.931.18	84.122.05
			1667325B034	A	1.810 x 10.56	K127W	70.127.23		ST70-33	91.127.23	84.122.05
	RSS-232-20K		1660189	B	1.999 x 11.21	KH931L	78.931.12		ST70-12	92.931.12	84.931.12
SPICER / DANA / EATON											
O2 CODES											
	6000# 02-ADA, 8000# 02-ADB, 02-ADV, 02-ADW		166027C91 101KK111	B	1.359 x 7.97	K102I	70.102.09		ST70-2	92.102.09	84.103.19
	8000# 02-AEM,	Before 10/2002	101KK111	B	1.359 x 7.97	K102I	70.102.09		ST70-2	92.102.09	84.103.19
	8000# 02-AEM, 02-AHA, 02-AGZ, 02-ADZ, 02-AGN	10/2002-Present	329182	C	1.359 x 7.97	K103S	70.103.19		ST70-2	93.103.19	84.103.19
	8000# 02-ATK		R201604	B	1.499 x 7.50	K80R	70.080.18		ST70-28		
	10000# 02-ADC, 02-ADL		1668411C91	B	1.921 x 9.87	K120I⁸	70.120.09 ⁸ 70.120.99 ^{3,8}		ST70-19	92.120.09	84.147.05
	12000# 02-ADD, 02-ADG, 02-ADN, 02-ADP	1989 to Date	1668411C91 120KK100	B	1.921 x 9.87	K120I⁸	70.120.09 ⁸ 70.120.99 ^{3,8}		ST70-19	92.120.09	84.147.05
	02-AEA		806355	A	1.625 x 9.19	K120E	70.120.05		ST70-6	91.120.05	84.120.05
	12000# 02-AED, 02-AEG		816787, 823078, 328344, 328342	A	1.794 x 9.05	K122E	70.122.05 70.122.95 ³		ST70-7	91.122.05	84.122.05
	12000# 02-AGA		328346, 328348	C	1.794 x 9.05	K123E	70.123.05		ST70-7	93.123.05	84.122.05
	12000# 02-ARK, 02-ARL, 02-ASB, 02-ASD		2500542C91	B	1.794 x 8.87	K981R	70.981.18		ST70-7	92.961.12	84.122.05
	12000# 02-ARA, 02-ARV, 02-ARW, 02-ASX		1665531C91	B	1.794 x 10.40	K961L	70.961.12		ST70-7	92.961.12	84.122.05
	02-ARG			B	1.794 x 10.40	KG931R	77.931.18		ST70-7	92.931.18	84.122.05
	12000# 02-ASV, 02-ASW, 02-AUB, 02-AUC, 02-AUD		60961-009, 60961-039, 60961-040						ST70-32		
	14000# 02-ADE, 02-ADT, 02-AES, 02-AET, 02-AGL, 02-AGV	1990 to Date	140KK100 329022	B	2.046 x 10.12	K141S⁸	70.141.19 ⁸		ST70-24		
	14600# 02-AEZ, 02-AGB, 02-AGC, 02-AGE		328347 328349	C	1.872 x 9.05	K147E	70.147.05		ST70-23	93.147.05	84.147.05
	16000# 02-ADH, 02-AEU, 02-AEV, 02-AEW, 18000# 02-ADJ, 20000# 02-ADK		220KK100 1685405C91	B	2.046 x 11.00	K160S	70.160.19		ST70-24	92.160.19	84.931.12
	18000# 02-ARU		2505495C91	B	1.999 x 11.21	K180R	70.180.18		ST70-12	92.180.18	84.931.12
	18000# 02-ARZ, 02-ARY			B	1.999 x 11.21	K181R	70.181.18		ST70-12	92.931.12	84.931.12
	20000# 02-ADY		220KK300 2599770C91	C	2.046 x 10.07	K201S			ST70-24	93.201.19	84.931.12

PIN TYPE CHART:

	A – SINGLE LOCK FLAT		C – SAME SIDE LOCK FLATS		G – STEP THREADED
	B – DOUBLE LOCK FLAT		E – TAPERED THREADED		H – NO LOCK FLATS
	J – SINGLE STEP		F – TAPERED		I – SINGLE STEP

1. STEMCO Kaiser QwikKit® feature patented spiral steel bushings. 2. STEMCO Kaiser PlusKit® feature pre-sized steel back bronze bushings. 3. Kit has composite bushings. 4. Modify spindles to receive end plates. 5. Bolt on cap. 6. Threaded cap. 7. Length of STEMCO Kaiser pin is 9 3/4". 8. STEMCO Kaiser pin is longer than OEM. 9. Torque Spec. for king pin nut 230 ft/lbs. 10. Torque Spec. for king pin nut is 300 ft/lbs. 11. Torque Spec. for king pin nut is 406 ft/lbs. 12. Torque Spec. for king pin nut is 350/475 ft/lbs. 13. Includes end caps. 14. Torque Spec. for knuckle attachment bolts is 170-200 ft/lbs. 15. Kit uses special removal tool ST90-1.

FOR ALL QWIKKIT® – BUSHING "T" HANDLE WRENCHES

TOOL NO.	DESCRIPTION	TOOL NO.	DESCRIPTION
ST-100-1	Short "T" Handle Wrench	ST-100-3	Short "T" Handle Wrench
ST-100-2	Long "T" Handle Wrench	ST-100-4	Long "T" Handle Wrench
100M1-1	Replacement head	100M1-2	Replacement head

Above Wrenches will fit the bushings in most kits. The Following kits do not use wrenches: K80A, K120A, K120N, K150KG, K160A, K700T, K60U

Above Wrenches will fit the bushings in the following kits: K50F, K71F, K72F, K80G, K110G, K120G, K122V, K146E, K147E, K180E, K68Z, K69Z



STEERING KNUCKLE KING PIN KITS

MODEL	AXLE	YEAR	OEM NO.	PIN TYPE	OEM SPEC	QWIKKIT NO. ¹	PLUSKIT NO. ²	ECONO KIT NO.	LIP SEAL/ BUSHING DRIVER INSTALLATION TOOL	AXLE SLEEVE USED WITH APE	APE CUTTER KIT USED
SPICER / DANA / EATON CONT.											
D CODES	6000# D600, 7000# D700, 8500# D850		329182	C	1.359 x 7.97	K103S	70.103.19		ST70-2	93.103.19	84.103.19
	8000# D800	Before 10/2002	101KK111	B	1.359 x 7.97	K102I	70.102.09		ST70-2	92.102.09	84.103.19
	8000# D800F	10/2002-Present	329182	C	1.359 x 7.97	K103S	70.103.19		ST70-2	93.103.19	84.103.19
	20000# D2000F, 22000# D2200F		331434	B	2.046 x 10.07	K200S			ST70-24		
	20000# D2000F, 22000# D2200F		331435, 220KK300, 2599770C91	C	2.046 x 10.07	K201S			ST70-24	93.201.19	84.931.12
E CODES	10000# E1000IW, 12000# E1200IW, E1201IW, 13200# E1320IW		823078, 328344, 328342	A	1.794 x 9.05	K122E	70.122.05		ST70-7	91.122.05	84.122.05
	12000# E1203I		328346, 328348	C	1.794 x 9.05	K123E	70.123.05		ST70-7	93.123.05	84.122.05
	14600# E1460IW		824530, 824920, 328345, 328343, 329404, 329405	A	1.872 x 9.05	K146E	70.146.05		ST70-23	91.146.05	84.147.05
	10000# E1002IW, 12000# E1202IW, 13200# E1322IW, 14600# E1462IW		328347, 328349	C	1.872 x 9.05	K147E	70.147.05		ST70-23	93.147.05	84.147.05
	10000# E1002IW, 12000# E1202IW, 13000# E1302I, TOP DEAD CENTER MOUNTED ADB		503700	C	1.872 x 8.66	K145E			ST70-23		
	EFA CODES	12000# EFA12F3		806356, 1005632	A	1.625 x 9.19	K121E	70.121.05		ST70-6	
	10000# EFA10F5, 12000# EFA12F4, 13200# EFA13F5		806355, 815984, 1008431	A	1.625 x 9.19	K120E	70.120.05		ST70-6	91.120.05	84.120.05
	18000# EFA18F3, EFA18F4, 20000# EFA20F4, 22000# EFA22T2, EFA22T5, 24000# EFA24T2, EFA24T5		811525, 1008500, 329432, 329433, 329434	A	1.872 x 9.97	K180E	70.180.05		ST70-23	91.180.05	84.147.05
I CODES	5000# I-050		473695C91	A	1.359 x 7.97	K101I	70.101.09	50.101.09	ST70-2	91.101.09	84.103.19
	6000# I-060		473695C91	A	1.359 x 7.97	K101I	70.101.09	50.101.09	ST70-2	91.101.09	84.103.19
	6000# I-60S, I-60SG, I-61		166027C91, 101KK111	B	1.359 x 7.97	K102I	70.102.09		ST70-2	92.102.09	84.103.19
	7500# I-075		473695C91	A	1.359 x 7.97	K101I	70.101.09	50.101.09	ST70-2	91.101.09	84.103.19
	8000# I-080		473695C91	A	1.359 x 7.97	K101I	70.101.09	50.101.09	ST70-2	91.101.09	84.103.19
	8000# I-80S, I-80SG		166027C91, 101KK111	B	1.359 x 7.97	K102I	70.102.09		ST70-2	92.102.09	84.103.19
	9000# I-090	Before Aug 1981	470752C91, 483095C91	A	1.609 x 9.16	K309I	70.309.09		ST70-5		

PIN TYPE CHART:

	A – SINGLE LOCK FLAT		E – TAPERED THREADED		H – NO LOCK FLATS
	B – DOUBLE LOCK FLAT		F – TAPERED		J – SINGLE STEP
	C – SAME SIDE LOCK FLATS		G – STEP THREADED		

1. STEMCO Kaiser QwikKit® feature patented spiral steel bushings. 2. STEMCO Kaiser PlusKit® feature pre-sized steel back bronze bushings. 3. Kit has composite bushings. 4. Modify spindles to receive end plates. 5. Bolt on cap. 6. Threaded cap. 7. Length of STEMCO Kaiser pin is 9 3/4". 8. STEMCO Kaiser pin is longer than OEM. 9. Torque Spec. for king pin nut 230 ft/lbs. 10. Torque Spec. for king pin nut is 300 ft/lbs. 11. Torque Spec. for king pin nut is 406 ft/lbs. 12. Torque Spec. for king pin nut is 350/475 ft/lbs. 13. Includes end caps. 14. Torque Spec. for knuckle attachment bolts is 170-200 ft/lbs. 15. Kit uses special removal tool ST90-1.

MODEL	AXLE	YEAR	OEM NO.	PIN TYPE	OEM SPEC	QWIKKIT NO. ¹	PLUSKIT NO. ²	ECONO KIT NO.	LIP SEAL/ BUSHING DRIVER INSTALLATION TOOL	AXLE SLEEVE USED WITH APE	APE CUTTER KIT USED
SPICER / DANA / EATON CONT.											
I CODES (cont.)	9000# I-090	After Aug 1981	586806C91	B	1.609 x 9.16	K310I	70.310.09		ST70-5		
	10000# I-100S, I-100SA, I-100SG		1668411C91	B	1.921 x 9.87	K120I	70.120.09 ⁸ , 70.120.99 ^{3,8}		ST70-19	92.120.09	84.147.05
	10800# I-108 All except code 02309		399942C93, 1658934C91, 586808C91	B	1.609 x 9.66	K140I	70.140.09		ST70-5	92.140.09	84.120.05
	10800# I-108 For code 02309		586806C91	B	1.609 x 9.16	K310I	70.310.09		ST70-5		
	12000# I-120 All except code 02309		399942C93, 1658934C91, 586808C91	B	1.609 x 9.66	K140I	70.140.09		ST70-5	92.140.09	84.120.05
	12000# I-120 For code 02309		586806C91	B	1.609 x 9.16	K310I	70.310.09		ST70-5		
	12000# I-120S, I-120SG, I-120SGL	1989 to date	1668411C91, 120KK100	B	1.921 x 9.87	K120I	70.120.09 ⁸ , 70.120.99 ^{3,8}		ST70-19	92.120.09	84.147.05
	13200# I-132		588808C91, 1658394C91	B	1.609 x 9.66	K140I	70.140.09		ST70-5	92.140.09	84.120.05
	14000# I-140S, I-140SG, I-140W, I-1325G	1990 to date	140KK100, 329022	B	2.046 x 10.12	K141S	70.141.19 ⁸		ST70-24		
	14600# I-146S, I-146SA		120KK102	B	1.860 x 10.75	K146S					
	16000# I-160S, I-160W, 18000# I-180S, I-180W, 20000# I-200S, I-200W, 22000# I-220S, I-220W		220KK100, 1685405C91, 329023	B	2.046 x 11.00	K160S	70.160.19		ST70-24	92.160.19	84.931.12
16000# I-160S, I-160SB for MCI Buses only		161KK100	B	2.046 x 11.00	K161S			ST70-24			

STERLING (SEE MERITOR, SPICER / DANA / EATON)

VOLVO

9000# FM9		85108338	E	2.360 x 8.92	K536M ¹⁵						
12000# FM12		85108338	E	2.360 x 8.92	K536M ¹⁵						
12000# FXL12		301SQ53	E	2.360 x 8.92	K536M ¹⁵						
14600# FXL14.6		301SQ53	E	2.360 x 8.92	K536M ¹⁵						
18000# FXL18		301SQ53	E	2.360 x 8.92	K536M ¹⁵						
20000# FXL20		301SQ53	E	2.360 x 8.92	K536M ¹⁵						
23000# FXL23		301SQ53	E	2.360 x 8.92	K536M ¹⁵						
10000# VF10, 12000# VF12, 12500# VF12S, FAX5.5, FAX5.7		3130711, V3090267	E	1.777 x 8.62	K122V ⁹						
VF14, VF16, VF18		3090266	E	1.969 x 9.88	K140V						
		3093704	B	1.794 x 8.87	K981R	70.981.18			ST70-7	92.961.12	84.122.05
		V1112810	A	1.625 x 9.19	K120E	70.120.05			ST70-6	91.120.05	84.120.05
		85106184	A	1.794 x 9.05	K122E	70.122.05			ST70-7	91.122.05	84.122.05

FOR ALL QWIKKIT® – BUSHING "T" HANDLE WRENCHES

TOOL NO.	DESCRIPTION	TOOL NO.	DESCRIPTION
ST-100-1	Short "T" Handle Wrench	ST-100-3	Short "T" Handle Wrench
ST-100-2	Long "T" Handle Wrench	ST-100-4	Long "T" Handle Wrench
100M1-1	Replacement head	100M1-2	Replacement head

Above Wrenches will fit the bushings in most kits. The Following kits do not use wrenches: K80A, K120A, K120N, K150KG, K160A, K700T, K60U

Above Wrenches will fit the bushings in the following kits: K50F, K71F, K72F, K80G, K110G, K120G, K122V, K146E, K147E, K180E, K68Z, K69Z

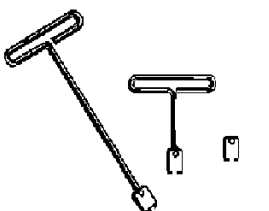

STEERING KNUCKLE KING PIN KITS

MODEL	AXLE	YEAR	OEM NO.	PIN TYPE	OEM SPEC	QWIKKIT NO. ¹	PLUSKIT NO. ²	ECONO KIT NO.	LIP SEAL/ BUSHING DRIVER INSTALLATION TOOL	AXLE SLEEVE USED WITH APE	APE CUTTER KIT USED
WATSON & CHALIN											
	SL8K w/ MERITOR AXLE		SRK103	B	1.500 x 8.93	K941R	70.941.18		ST70-28		
	SL8K w/ WESTPORT AXLE		SRK115	B	1.500 x 8.93	K81W			ST70-28		
	1100 Series w/ MERITOR AXLE		SRK102	B	1.794 x 10.40	K961L	70.961.12		ST70-7	91.961.12	84.122.05
	1100 Series w/ WESTPORT AXLE		SRK98 SRK112	B	1.794 x 10.40	K130W	70.130.23		ST70-7	91.961.12	84.122.05
	SL2089, SL2090, S1TL2095, S1TL2096 w/ MERITOR AXLE		SRK105	B	1.999 x 11.21	KH931L	78.931.12		ST70-12	92.931.12	84.931.12
	SL2089, SL2090, S1TL2095, S1TL2096 w/ WESTPORT AXLE		SRK120	B	1.999 x 11.21	K181R	70.181.18		ST70-12	92.931.12	84.931.12
WHITE / WESTPORT											
Trend Models	7000#	1966-1967		B	1.234 x 7.43	K70D		50.070.04	ST70-10		
	F4W-0800		143698-0040	B	1.300 x 7.75	K72F			ST70-17		
	F3W-1200 F5W-1200 F6W-1200 (12000#)	1952-1975	216446	A	1.810 x 10.78	K120W					
	F3W-1300, F3W-1400, F3W-1600, F6W-1300, F6W-1400, F6W-1600		143698-0052	A	1.810 x 10.56	K127W	70.127.23		ST70-33	91.127.23	84.122.05
	F3W-125 (12000#)	1975 to date	143698-0001	A	1.810 x 10.56	K125W	70.125.23	50.125.23	ST70-33		
	F3W-140, F5W-140, F6W-140 (14000#)	1966-1975	216446	A	1.810 x 10.78	K120W					
	F3W, F6W, 1200 Series	1975 to date	37090-5005 143698-0051	A	1.810 x 10.56	K126W	70.126.23		ST70-33	91.127.23	84.122.05
	F3W, F6W 1400 Series	1975 to date	217175 143698-0001	A	1.810 x 10.56	K125W	70.125.23	50.125.23	ST70-33		
	F0W-1800, F3W-2000, F2W-2000D		143698-0018	B	1.999 x 11.21	K181R	70.181.18		ST70-12	92.931.12	84.931.12
	9000# (FD-901)	1960-1967	138, 142, 154	B	1.434 x 8.50	KD901R	74.901.18		ST70-9		
	12000# (FE-900)	1955-1965	857328	E	1.609 x 9.75	K125G¹²			ST70-5		
	16000# (FH-901)	1965-1975	168, 170	B	1.999 x 11.04	KH901L			ST70-9		
	18000# (FL-901)	1965-1975	1720728 1739844	B	1.999 x 11.04	KH901L			ST70-12		
Westport Axle	WS1637090-4405		143698-0051	A	1.811 x 10.56	K126W	70.126.23		ST70-33	91.127.23	84.122.05
	F5W0900		143698-0053	B	1.606 x 9.08	K96F			ST70-13		
WORKHORSE											
			8006372	A	1.179 x 6.36	K58G	70.058.07		ST70-4		
			8803055	A	1.179 x 6.36	K56G	70.056.07		ST70-4	91.056.07	84.056.07
			8003056	A	1.179 x 7.31	K50W			ST70-4	91.050.23	84.056.07
			8007232	B	1.300 x 7.75	K72F			ST70-17		

PIN TYPE CHART:

	A - SINGLE LOCK FLAT		E - TAPERED THREADED		H - NO LOCK FLATS
	B - DOUBLE LOCK FLAT		F - TAPERED		J - SINGLE STEP
	C - SAME SIDE LOCK FLATS		G - STEP THREADED		

1. STEMCO Kaiser QwikKit® feature patented spiral steel bushings. 2. STEMCO Kaiser PlusKit® feature pre-sized steel back bronze bushings. 3. Kit has composite bushings. 4. Modify spindles to receive end plates. 5. Bolt on cap. 6. Threaded cap. 7. Length of STEMCO Kaiser pin is 9 3/4". 8. STEMCO Kaiser pin is longer than OEM. 9. Torque Spec. for king pin nut is 230 ft/lbs. 10. Torque Spec. for king pin nut is 300 ft/lbs. 11. Torque Spec. for king pin nut is 406 ft/lbs. 12. Torque Spec. for king pin nut is 350/475 ft/lbs. 13. Includes end caps. 14. Torque Spec. for knuckle attachment bolts is 170-200 ft/lbs. 15. Kit uses special removal tool ST90-1.

BUS STEERING KNUCKLE KING PIN KITS

MODEL	AXLE	YEAR	OEM NO.	PIN TYPE	OEM SPEC	QWIKKIT NO. ¹	PLUSKIT NO. ²	ECONO KIT NO.	LIP SEAL/ BUSHING DRIVER INSTALLATION TOOL	AXLE SLEEVE USED WITH APE	APE CUTTER KIT USED
BLUEBIRD											
All American	Airtek Softek 649505-0004		00063311 LT SIDE 00063312 RT SIDE 00063313 BT SIDES						ST70-32		
	12000# FF-942			B	1.794 x 10.40	K931L	70.931.12		ST70-7	92.961.12	84.122.05
	12000# I-120S, I-120SG, I-120SGL		8305203	B	1.921 x 9.87	K120⁸	70.120.09 ⁸ 70.120.99 ^{3,8}		ST70-19	92.120.09	84.147.05
TC2000	12000# I-120SA, I-120IS, I-126SA, I-126IS 14600# I-146SA	1990-	4294716	B	1.859 x 10.75	K146S					
	14000# I-140S I-140SG, I-146		8305211	B	2.046 x 10.12	K141S⁸	70.141.19 ⁸		ST70-24		
	10,800#	1988-1989	2156784 4293270	B	1.609 x 9.66	K140I	70.140.09		ST70-5	92.140.09	84.120.05
Meritor Axles	12,000-13,200# FF-934, FF-942, FF-944		195, 1307	B	1.794 x 10.40	K931L	70.931.12		ST70-7	92.961.12	84.122.05
Uses Lock Pin Sizes 3.68 & 3.25	13,200# FF-961, FF-967		1315 4280855	B	1.794 x 10.40	K961L	70.961.12		ST70-7	92.961.12	84.122.05
	14,600# FG-941, FG-943		1309 1310	B	1.794 x 10.40	KG931R	77.931.18		ST70-7	92.931.18	84.122.05
FORD											
	7000# Hyd. Brakes	1967-1988	C7TZ-3111A	A	1.231 x 8.90	K70F⁴			ST70-3		
	7000-9000# Air Brakes	1975-1988	D6TZ-3111A	B	1.433 x 8.25	K75F⁵	70.075.06 ⁵		ST70-9		
	7000-9000# Air Brakes	1989-	E9HZ-3111C	B	1.433 x 8.25	K76F⁶	70.076.06 ⁶		ST70-9		
	9000# Hyd. Brakes	1960-1983	D1HZ-3111A C2TZ-3111G	B	1.434 x 8.50	KD901R	74.901.18		ST70-9		
	9000# Air Brakes	1975-1988	D6HZ-3111B	B	1.606 x 9.07	K95F⁵			ST70-13		
	9000# Air Brakes	1989-	E9HZ-3111B	B	1.606 x 9.07	K96F⁶			ST70-9		
GILLIG											
	14600#FG-931		1309, 1310 1319, 1471	B	1.794 x 10.40	KG931R	77.931.18		ST70-7	92.931.18	84.122.05
	16000# FH-946		1420, 1424	B	1.794 x 9.19	KH946R	78.946.18		ST70-7	92.946.18	84.122.05

FOR ALL QWIKKIT® - BUSHING "T" HANDLE WRENCHES

TOOL NO.	DESCRIPTION	TOOL NO.	DESCRIPTION
ST-100-1	Short "T" Handle Wrench	ST-100-3	Short "T" Handle Wrench
ST-100-2	Long "T" Handle Wrench	ST-100-4	Long "T" Handle Wrench
100M1-1	Replacement head	100M1-2	Replacement head

Above Wrenches will fit the bushings in most kits. The Following kits do not use wrenches: K80A, K120A, K120N, K150KG, K160A, K700T, K60U

Above Wrenches will fit the bushings in the following kits: K50F, K71F, K72F, K80G, K110G, K120G, K122V, K146E, K147E, K180E, K68Z, K69Z

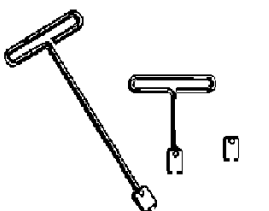





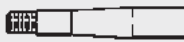

BUS STEERING KNUCKLE KING PIN KITS

MODEL	AXLE	YEAR	OEM NO.	PIN TYPE	OEM SPEC	QWIKKIT NO. ¹	PLUSKIT NO. ²	ECONO KIT NO.	LIP SEAL/ BUSHING DRIVER INSTALLATION TOOL	AXLE SLEEVE USED WITH APE	APE CUTTER KIT USED
GMC COACH											
Transit Coach	7000#		2470621	B	1.234 x 7.43	K70D			ST70-10		
	12000#		2362900 2237497	E	1.609 x 9.75	K125G¹²			ST70-5		
	15000# 16000#		2254366 IC-2-40	E	1.794 x 10.68	K170G¹²					
INTERNATIONAL / NAVISTAR											
	6000#, I-60S (02-ADA)		1660271C92	B	1.359 x 7.97	K102I	70.102.09		ST70-2	92.102.09	84.103.19
	8000#, I-80S (02-ADB)		1660271C92	B	1.359 x 7.97	K102I	70.102.09		ST70-2	92.102.09	84.103.19
	10,000#, I-100S (02-ADC) 12,000#, I-120S (02-ADD)			B	1.921 x 9.87	K120I⁸	70.120.09 ⁸ 70.120.99 ⁸		ST70-19	92.120.09	84.147.05
	14,000#, I-140S (02-ADE) (02-AGV)		1668412C91	B	2.046 x 10.12	K141S⁸	70.141.19 ⁸		ST70-24		
MAN											
	V8-65C-02	1993	81-44205-6013 6313078	J	1.969 x 8.77	K120N			ST70-27		
MCI											
MC-7, MC-8, MC-9	15000# 16000#		2254366 IC-2-40	E	1.794 x 10.68	K170G¹²					
	13200# FF-941, FF-961			B	1.794 x 10.40	K961L	70.961.12		ST70-7	92.961.12	84.122.05
MC-12	14600# FG-931		IJ-2-54	B	1.794 x 10.40	KG931R	77.931.18		ST70-7	92.931.18	84.122.05
102DL3	16000# 20000# FH-946		01-01-1017 01-01-1079	B	1.794 x 9.19	KH946R	78.946.18		ST70-7	92.946.18	84.122.05
G Coach	16000# I-160S			B	2.046 x 11.00	K161S			ST70-24		
MERITOR											
	14,600# 17100, 17101, 17111, 17801		R201309 R201310 R201319 R201471	B	1.794 x 10.40	KG931R	77.931.18		ST70-7	92.931.18	84.122.05
	8000# MFS-08		R201474	B	1.500 x 7.50	K80R	70.080.18		ST70-28		
	12000# FF-931, FF-932, FF-933, FF-934		R200195 R201307	B	1.794 x 10.40	K931L	70.931.12		ST70-7	92.961.12	84.122.05
1-599 SERIES	13200# FF-941, FF-942, FF-943, FF-944, FF-945		R200195 R201307	B	1.794 x 10.40	K931L	70.931.12		ST70-7	92.961.12	84.122.05

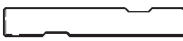
MODEL	AXLE	YEAR	OEM NO.	PIN TYPE	OEM SPEC	QWIKKIT NO. ¹	PLUSKIT NO. ²	ECONO KIT NO.	LIP SEAL/ BUSHING DRIVER INSTALLATION TOOL	AXLE SLEEVE USED WITH APE	APE CUTTER KIT USED
MERITOR CONT.											
600 SERIES	13200# FF-941, FF-942, FF-943, FF-944, FF-945		R201315 R201470	B	1.794 x 10.40	K961L	70.961.12		ST70-7	92.961.12	84.961.12
	13200# FF-961, FF-962, FF-966, FF-967, FC-965		R201315 R201470	B	1.794 x 10.40	K961L	70.961.12		ST70-7	92.961.12	84.961.12
	14600#, FG-931 FG-933, FG-941, FG-943, FG-952		R201309 R201310 R201319 R201471	B	1.794 x 10.40	KG931R	77.931.18		ST70-7	92.931.18	84.122.05
	16000# FH-941, 20000# FH-945, FH-946		R201420 R201424	B	1.794 x 9.19	KH946R	78.946.18		ST70-7	92.946.18	84.122.05
	18000# FL-931, FL-933, FL-941, FL-943, FL-951		R200198 R201312	B	1.999 x 11.21	KH931L	78.931.12		ST70-12	92.931.12	84.931.12
NEW FLYER											
	MAN		6313078	J	1.969 x 8.77	K120N			ST70-27		
THOMAS											
ER-Series School Bus Chassis; Rear Engine			8314171	B	1.359 x 7.97	K102I	70.102.09		ST70-2	92.102.09	84.103.19
	13,200# FF-932		1307	B	1.794 x 10.40	K931L	70.931.12		ST70-7	92.961.12	84.122.05
	14,600# FG-941, FG-944		1309 1310	B	1.794 x 10.40	KG931R	77.931.18		ST70-7	92.931.18	84.122.05
	AF-10.0-3, AF-12.0-3, AF-13.0-3, AF-13.3-3, AF-14.7-3		P6073300019KZ P6073300119KZ	B	1.771 x 9.23	K120A			ST70-30	92.120.01	84.122.05

PIN TYPE CHART:

	A – SINGLE LOCK FLAT		E – TAPERED THREADED		H – NO LOCK FLATS
	B – DOUBLE LOCK FLAT		F – TAPERED		J – SINGLE STEP
	C – SAME SIDE LOCK FLATS		G – STEP THREADED		

1. STEMCO Kaiser QwikKit® feature patented spiral steel bushings. 2. STEMCO Kaiser PlusKit® feature pre-sized steel back bronze bushings. 3. Kit has composite bushings. 4. Modify spindles to receive end plates. 5. Bolt on cap. 6. Threaded cap. 7. Length of STEMCO Kaiser pin is 9 3/4". 8. STEMCO Kaiser pin is longer than OEM. 9. Torque Spec. for king pin nut 230 ft/lbs. 10. Torque Spec. for king pin nut is 300 ft/lbs. 11. Torque Spec. for king pin nut is 406 ft/lbs. 12. Torque Spec. for king pin nut is 350/475 ft/lbs. 13. Includes end caps. 14. Torque Spec. for knuckle attachment bolts is 170-200 ft/lbs. 15. Kit uses special removal tool ST90-1.

FOR ALL QWIKKIT® – BUSHING "T" HANDLE WRENCHES

TOOL NO.	DESCRIPTION	TOOL NO.	DESCRIPTION
ST-100-1	Short "T" Handle Wrench	ST-100-3	Short "T" Handle Wrench
ST-100-2	Long "T" Handle Wrench	ST-100-4	Long "T" Handle Wrench
100M1-1	Replacement head	100M1-2	Replacement head

Above Wrenches will fit the bushings in most kits. The Following kits do not use wrenches: K80A, K120A, K120N, K150KG, K160A, K700T, K60U

Above Wrenches will fit the bushings in the following kits: K50F, K71F, K72F, K80G, K110G, K120G, K122V, K146E, K147E, K180E, K68Z, K69Z

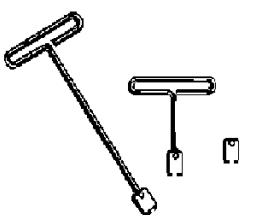

KING PIN DIMENSIONS INTERCHANGES

DIA.	LENGTH	TYPE	MAKE	QWIKKIT	PLUSKIT	ECONO KIT
1.054	6.690	A	FORD	KE350F		
1.101	7.100	A	mitsubishi	K60U	NA	NA
1.109	6.340	A	CHEVY	K51G	70.051.07	50.051.07
1.179	6.360	A	CHEVY	K55G	70.051.07	
1.179	6.360	A	CHEVY	K56G	70.056.07	
1.179	6.360	A	WORKHORSE	K58G	70.058.07	NA
1.179	7.310	A	WORKHORSE	K50W	NA	NA
1.181	7.380	A	ISUZU	K68Z	70.068.26	NA
1.181	7.380	A	ISUZU	K69Z	70.069.26	NA
1.230	8.906	A	FORD	K70F		
1.231	7.859	A	FORD	K50F	70.053.06	
1.234	6.780	A	MERITOR	K60R	NA	NA
1.234	7.437	B	DODGE	K70D		
1.234	7.660	A	IH	K98I	70.098.09	50.098.09
1.249	7.875	A	CHEVY	K70G	70.070.07	
1.300	7.270	A	FORD	K71F		
1.300	7.750	B	FORD	K72F		
1.359	7.970	C	DANA	K103S	70.103.19	
1.359	7.970	A	IH	K101I	70.101.09	50.101.09
1.359	7.970	B	IH	K102I	70.102.09	
1.377	7.000	A	MACK	K75M	NA	NA
1.430	8.250	B	FORD	K75F	70.075.06	
1.430	8.250	B	FORD	K76F	70.076.06	
1.433	8.500	B	MERITOR	KD901R	74.901.18	
1.484	8.850	A	IH	K108I	NA	NA
1.484	8.850	B	IH	K109I	NA	NA
1.500	7.150	B	MERITOR	K70R	70.070.18	
1.500	7.400	F	MACK	K535M	NA	NA
1.500	7.500	B	MERITOR	K80R	70.080.18	
1.500	8.930	B	WATSON CHALIN	K81W	NA	NA
1.500	8.930	B	MERITOR	K941R	70.941.18	
1.606	8.812	B	MERITOR	K970R		
1.606	9.080	B	FORD	K95F		
1.606	9.080	B	FORD	K96F		
1.609	9.160	A	IH	K309I	70.309.09	
1.609	9.160	B	IH	K310I	70.310.09	
1.609	9.380	B	MERITOR	K971R		
1.609	9.660	A	IH	K139I	70.139.09	
1.609	9.660	B	IH	K140I	70.140.09	
1.609	9.750	E	CHEVY	K125G		
1.614	8.000	G	CHEVY	K80G	NA	NA
1.625	7.468	F	MACK	K533M	70.533.13	
1.625	9.190	A	EATON	K120E	70.120.05	
1.625	9.190	A	EATON	K121E	70.121.05	
1.745	9.380	B	CHEVY	K121G		
1.771	8.060	B	ALLIANCE	K80A	NA	NA
1.771	9.230	B	ALLIANCE	K120A	NA	NA
1.777	8.620	E	VOLVO	K122V	NA	NA
1.794	8.840	B	MERITOR		NA	NA
1.794	8.870	B	MERITOR	K981R	70.981.18	
1.794	9.020	B	MERITOR	K130R	NA	NA
1.794	9.020	B	MERITOR	K131R	NA	NA

DIA.	LENGTH	TYPE	MAKE	QWIKKIT	PLUSKIT	ECONO KIT
1.794	9.050	A	EATON	K122E	70.122.05	
1.794	9.050	A	LINK	K123K	NA	NA
1.794	9.050	A	LINK	K132K	NA	NA
1.794	9.180	B	MERITOR	K901L	70.901.12	
1.794	9.190	B	MERITOR	KH946R	78.946.18	
1.794	9.050	C	DANA	K123E	70.123.05	
1.794	10.070	B	WATSON CHALIN	K130W	70.130.23	
1.794	10.070	B	FORD	K941F	70.941.06	
1.794	10.070	B	FORD	K942F	70.942.06	
1.794	10.392	B	MERITOR	K120R	70.120.18	
1.794	10.400	B	MERITOR	K931L	70.931.12	
1.794	10.400	B	MERITOR	K961L	70.961.12	
1.794	10.400	B	MERITOR	KG931R	77.931.18	
1.794	10.390	B	MERITOR	K921L	70.921.12	
1.794	10.687	E	GMC COACH	K170G	NA	NA
1.810	9.540	H	HENDRICKSON	K120H	NA	NA
1.810	9.540	A	HENDRICKSON	K131H	NA	NA
1.810	10.530	B	FORD	K146F	NA	NA
1.810	10.560	A	WESTPORT	K125W	70.125.23	70.125.23
1.810	10.560	A	WESTPORT	K126W	70.126.23	
1.810	10.560	A	WESTPORT	K127W	70.127.23	
1.810	10.781	A	WESTPORT	K120W	NA	NA
1.860	10.750	B	SPICER	K146S	NA	NA
1.872	8.660	C	DANA	K145E	NA	NA
1.872	9.050	C	DANA	K147E	70.147.05	70.147.05
1.872	9.050	C	DANA	K149E	NA	NA
1.872	9.050	A	EATON	K146E	70.146.05	
1.872	9.970	A	EATON	K180E	70.180.05	
1.889	9.200	G	CHEVY	K110G	NA	NA
1.889	9.620	G	CHEVY	K120G	NA	NA
1.921	9.875	B	IH	K120I	70.120.09	
1.921	10.625	B	IH	K120I	70.120.09	
1.969	8.770	J	MAN	K120N	NA	NA
1.969	9.880	E	VOLVO	K140V	NA	NA
1.999	10.790	B	MERITOR	K200R	NA	NA
1.999	11.040	B	MERITOR	KH901L		
1.999	11.212	B	MERITOR	K180R	70.180.18	50.180.19
1.999	11.212	B	MERITOR	K181R	NA	NA
1.999	11.212	B	FORD	KH931F	78.931.06	
1.999	11.212	B	MERITOR	KH931L	78.931.12	
1.999	11.320	A	KGI	K150KG	NA	NA
2.046	10.070	B	DANA	K200S	NA	NA
2.046	10.070	C	DANA	K201S	NA	NA
2.046	10.120	B	IH / SPICER	K141S	70.141.19	
2.046	11.000	B	DANA	K161S	NA	NA
2.046	11.000	B	SPICER	K160S	70.160.19	
2.125	8.750	F	MACK	K616M	70.616.13	
2.125	9.750	B	ALLIANCE	K160A	NA	NA
2.248	11.300	B	IMT / INGERSOLL	K700T	70.700.20	NA
2.249	10.600	A	KGI	K230KG	70.230.07	NA
2.441	8.920	E	MACK	K536M	NA	NA

KING PIN SUPPORT INFORMATION AND PRODUCTS

SPINDLE BORE AND AXLE BORE SIZES

KAISER DESIGN	SPINDLE BORE SIZE	AXLE BORE SIZES	KAISER DESIGN	SPINDLE BORE SIZE	AXLE BORE SIZES	KAISER DESIGN	SPINDLE BORE SIZE	AXLE BORE SIZES
K101I	1.483/1.485	1.358/1.360	K146S	1.994/1.996	1.862/1.864	K71D	1.358/1.360	1.235/1.237
K102I	1.483/1.485	1.358/1.360	K147E	2.057/2.058	1.873/1.875	K71F	1.460/1.462	1.301/1.303
K103S	1.483/1.485	1.358/1.360	K149E	2.057/2.058	1.873/1.875	K72F	1.454/1.456	1.301/1.303
K108I	1.608/1.610	1.485/1.487	K150KG	2.373/2.374	2.000/2.002	K75F	1.560/1.562	1.433/1.435
K109I	1.608/1.610	1.485/1.487	K160A	2.440/2.442	2.126/2.128	K75M	1.652/1.654	1.378/1.380
K110G	2.047/2.049	1.891/1.893	K160S	2.171/2.173	2.047/2.048	K76F	1.560/1.562	1.433/1.435
K120A	2.045/2.047	1.772/1.774	K161S	2.171/2.173	2.047/2.048	K80A	2.045/2.047	1.772/1.774
K120E	1.749/1.750	1.626/1.627	K170G	1.919/1.921	Tapered	K80G	1.771/1.773	1.615/1.617
K120G	2.047/2.049	1.891/1.893	K180E	2.057/2.058	1.873/1.875	K80R	1.626/1.628	1.501/1.503
K120H	1.937/1.939		K180R	2.124/2.126	2.000/2.002	K81W	1.626/1.628	1.501/1.503
K120I	2.045/2.047	1.922/1.923	K181R	2.124/2.126	2.000/2.002	K901L	1.919/1.921	1.795/1.797
K120N	2.283/2.284	1.967/1.968	K200R	2.124/2.126	2.000/2.002	K921L	1.919/1.921	1.795/1.797
K120R	1.919/1.921	1.795/1.797	K200S	2.171/2.172	2.047/2.048	K931L	1.919/1.921	1.795/1.797
K120W	1.937/1.939	1.811/1.812	K201S	2.171/2.172	2.047/2.048	K941F	1.919/1.921	1.795/1.797
K121E	1.749/1.750	1.626/1.627	K230KG	2.624/2.626	2.250/2.252	K941FA	1.919/1.921	1.795/1.797
K121G	1.876/1.878	1.745/1.747	K309I	1.733/1.735	1.610/1.612	K941R	1.626/1.628	1.501/1.503
K122E	1.919/1.921	1.794/1.796	K310I	1.733/1.735	1.610/1.612	K942F	1.919/1.921	1.795/1.797
K122V	1.969/1.971	Tapered	K50F	1.375/1.377	1.232/1.234	K942FA	1.919/1.921	1.795/1.797
K123E	1.919/1.921	1.794/1.796	K50W	1.314/1.316	1.180/1.182	K95F	1.733/1.735	1.607/1.609
K123K	1.919/1.921	1.794/1.796	K51G	1.229/1.231	1.110/1.112	K961L	1.919/1.921	1.795/1.797
K125G	1.733/1.735	Tapered	K533M	1.749/1.751	Tapered	K96F	1.733/1.735	1.607/1.609
K125W	1.937/1.939	1.811/1.812	K535M	1.624/1.626	Tapered	K970R	1.733/1.735	1.608/1.610
K126W	1.936/1.938	1.811/1.812	K536M	2.559/2.561	Tapered	K971R	1.733/1.735	1.608/1.610
K127W	1.936/1.938	1.811/1.812	K55G	1.298/1.300	1.180/1.182	K981R	1.920/1.921	1.795/1.797
K130R	1.919/1.921	1.795/1.797	K56G	1.314/1.316	1.180/1.182	K98I	1.358/1.360	1.235/1.237
K130W	1.919/1.921	1.795/1.797	K58G	1.314/1.316	1.180/1.182	KD901R	1.560/1.562	1.434/1.436
K131H	1.937/1.939	1.811/1.812	K60R	1.358/1.360	1.235/1.237	KE350F	1.179/1.181	1.055/1.057
K131R	1.919/1.921	1.795/1.797	K60U	1.337/1.339	1.102/1.104	KG931R	1.919/1.921	1.795/1.797
K132K	1.919/1.921	1.794/1.796	K616M	2.499/2.501	Tapered	KH901L	2.124/2.126	2.000/2.002
K139I	1.733/1.735	1.610/1.612	K68Z	1.338/1.340	1.182/1.184	KH931F	2.124/2.126	2.000/2.002
K140I	1.733/1.735	1.610/1.612	K69Z	1.338/1.340	1.182/1.184	KH931L	2.124/2.126	2.000/2.002
K140V	2.164/2.166	TAPERED	K700T	2.499/2.501	2.250/2.252	KH946R	1.919/1.921	1.795/1.797
K141S	2.171/2.173	2.047/2.048						
K145E	2.057/2.058	1.873/1.875						
K146E	2.057/2.058	1.873/1.875						
K146F	1.936/1.938	1.811/1.812						

FOR ALL QWIKKIT® – BUSHING “T” HANDLE WRENCHES

TOOL NO.	DESCRIPTION	TOOL NO.	DESCRIPTION
ST-100-1	Short "T" Handle Wrench	ST-100-3	Short "T" Handle Wrench
ST-100-2	Long "T" Handle Wrench	ST-100-4	Long "T" Handle Wrench
100M1-1	Replacement head	100M1-2	Replacement head

Above Wrenches will fit the bushings in most kits. The Following kits do not use wrenches: K80A, K120A, K120N, K150KG, K160A, K700T, K60U

Above Wrenches will fit the bushings in the following kits: K50F, K71F, K72F, K80G, K110G, K120G, K122V, K146E, K147E, K180E, K68Z, K69Z



KING PIN SUPPORT INFORMATION AND PRODUCTS

PLUSKIT® KING PIN BUSHING DRIVERS

PLUSKIT NO.	DRIVER NO.	PLUSKIT NO.	DRIVER NO.	PLUSKIT NO.	DRIVER NO.	PLUSKIT NO.	DRIVER NO.
70.053.06	ST70-3	70.076.06	ST70-9	70.126.23	ST70-33	70.616.13	ST70-18
70.055.07	ST70-4	70.080.18	ST70-28	70.127.23	ST70-33	70.700.20	ST70-29
70.056.07	ST70-4	70.095.07	ST70-9	70.130.23	ST70-7	70.901.12	ST70-7
70.058.07	ST70-4	70.098.09	ST70-10	70.139.09	ST70-5	70.921.12	ST70-7
70.068.26	ST70-37	70.101.09	ST70-2	70.140.09	ST70-5	70.931.12	ST70-7
70.069.26	ST70-37	70.102.09	ST70-2	70.141.19	ST70-24	70.941.06	ST70-7
70.070.07	ST70-1	70.103.19	ST70-2	70.146.05	ST70-23	70.941.18	ST70-28
70.070.18	ST70-28	70.120.05	ST70-6	70.147.05	ST70-23	70.942.06	ST70-7
70.075.06	ST70-9	70.120.09	ST70-19	70.160.19	ST70-24	70.961.12	ST70-7
		70.120.18	ST70-7	70.180.05	ST70-23	70.981.18	ST70-7
		70.120.99	ST70-19	70.180.18	ST70-12	74.901.18	ST70-9
		70.121.05	ST70-6	70.181.18	ST70-12	74.931.18	ST70-13
		70.122.05	ST70-7	70.230.07	ST70-29	77.931.18	ST70-7
		70.122.95	ST70-7	70.309.09	ST70-5	78.931.06	ST70-12
		70.123.05	ST70-7	70.310.09	ST70-5	78.931.12	ST70-12
		70.125.23	ST70-33	70.533.13	ST70-6	78.946.18	ST70-7



“NO GO” GAUGE KIT

STK81

CONTAINS:

ST81-1, ST81-2, ST81-3, ST81-4, ST81-5, ST81-6



“NO GO” GAUGE TOOLS			“NO GO” GAUGE TOOLS		
NO-GO	QWIKKIT	PLUSKIT	NO-GO	QWIKKIT	PLUSKIT
ST81-1	K981R*	70.981.18	ST81-2	K58G	70.058.07
ST81-1	K122E*	70.122.05	ST81-2	K50W	NA
ST81-1	K123K	NA	ST81-3	K103S	70.103.19
ST81-1	K132K	NA	ST81-3	K101I	70.101.09
ST81-1	K901L	70.901.12	ST81-3	K102I	70.102.09
ST81-1	KH946R*	78.946.18	ST81-4	K120E	70.120.05
ST81-1	K123E*	70.123.05	ST81-4	K121E	70.121.05
ST81-1	K941F	70.941.06	ST81-5	K147E	70.147.05
ST81-1	K942F	70.942.06	ST81-5	K146E	70.146.05
ST81-1	K120R	70.120.18	ST81-5	K180E	70.180.05
ST81-1	K931L*	70.931.12	ST81-6	KH901L	
ST81-1	K961L*	70.961.12	ST81-6	K180R	70.180.18
ST81-1	KG931R	77.931.18	ST81-6	K181R	70.181.18
ST81-1	K921L	70.921.12	ST81-6	KH931L	78.931.12
ST81-2	K55G	70.055.07	ST81-6	K150KG	NA
ST81-2	K56G	70.056.07			

PART NUMBERS BELOW REQUIRE SPECIAL BUSHING DRIVER



KIT NO.	TOOL NO.	KIT NO.	TOOL NO.
K75M	ST70-25	K230KG	ST70-29
K80A	ST70-30	K230KG	ST70-29
K120A	ST70-30	K700T	ST70-29
K120N	ST70-27	K60U	ST70-34
K160A	ST70-31		

KING PIN KIT INTERCHANGE

PART NO.	QWIKKIT	PLUSKIT	ECONO KIT	PART NO.	QWIKKIT	PLUSKIT	ECONO KIT	PART NO.	QWIKKIT	PLUSKIT	ECONO KIT
ALLIANCE AXLE				4280855	K961L	70.961.12		M-2391	K56G	70.056.07	
P6073300019KZ	K120A			4293270	K140I	70.140.09		M-2392	K72F		
P6073300119KZ	K120A			4294716	K146S			M-2397	K122E	70.122.05	
P6073300219KZ	K80A			8305203	K120I	70.120.09		CHEVROLET / GMC			
P6073300319KZ	K80A			8305211	K141S	70.141.19		722166	K55G	70.055.07	
P6073300419KZ	K160A			8314171	K102I	70.102.09		859552	K901L	70.901.12	
P6073300519KZ	K160A			BWP				1561960	K80G		
AUTOCAR				M-2300	K51G			1561961	K110G		
836687	K125G			M-2301	K98I	70.098.09	50.098.09	1561962	K120G		
857328	K125G			M-2305	K125G			2010021	K931L	70.931.12	
859552	K970R			M-2309	K125G			2036352	KH931L	78.931.12	
1715447	K970R			M-2310	K50F	70.053.06		2224495	K51G		
1739844	KH901L			M-2311	KD901R	74.901.18		2254366	K170G		
02-7091941	K921L	70.921.12		M-2312	KD901R	74.901.18		2264897	K125G		
AUTOMANN				M-2315	K901L	70.901.12		2362900	K125G		
460.102B	K70G	70.070.07		M-2316	K70G	70.070.07		2442145	K970R		
460.105B	K68Z	70.068.26		M-2317	K70G	70.070.07		2452865	KH901L		
460.106B	K69Z	70.069.26		M-2318	K51G			2470621	K70D		
460.122B	K970R			M-2319	K51G			2927942	K51G		
460.148B	K921L	70.921.12		M-2320	K70F			3691111	K51G		
460.160B	K140I	70.140.09		M-2321	K70F			3745285	KD901R	74.901.18	
460.162B	K75F	70.075.06		M-2322	K901L	70.901.12		3829410	K51G		
460.164B	K55G	70.055.07		M-2325	K109I			3829970	K70G	70.070.07	
460.166B	KH931L	78.931.12		M-2326	K970R			3838390	K70G	70.070.07	
460.168B	K941F	70.941.06		M-2327	K970R			3853990	K51G		
460.172B	KE350F			M-2331	K921L	70.921.12		3853994	K70G	70.070.07	
460.186B	KE350F			M-2332	K140I	70.140.09		3854744	K51G		
460.194B	K533M	70.533.13		M-2333	K140I	70.140.09		3858389	K51G		
460.196B	K121G			M-2334	K75F	70.075.06		3858390	K70G	70.070.07	
460.200B	K126W	70.126.23		M-2335	K55G	70.055.07		3927942	K51G		
460.204B	K931L	70.931.12		M-2336	KH901L			3927943	K70G	70.070.07	
460.206B	K310I	70.310.09		M-2337	KE350F			8885621	K121G		
460.207B	K700T	70.700.20		M-2338	K95F			8885856	K121G		
460.212B	K616M	70.616.13		M-2339	KH931L	78.931.12		8885857	K70G	70.070.07	
460.216B	K140I	70.140.09		M-2340	K941F	70.941.06		12472161	K56G	70.056.07	
460.220C	K120E	70.120.05		M-2341	K101I	70.101.09	50.101.09	12472162	K58G	70.058.07	
460.244B	K102I	70.102.09		M-2342	K108I			12540328	K80G		
460.246B	K961L	70.961.12		M-2343	K139I	70.139.09		12540329	K110G		
460.254B	K120E	70.120.05		M-2344	K139I	70.139.09		12540330	K120G		
460.255N	K122V			M-2345	K309I	70.309.09		12541348	K180E	70.180.05	
460.260B	K120I	70.120.09		M-2347	K533M	70.533.13		15510849	K931L	70.931.12	
460.260C	K120I	70.120.09		M-2348	K931L	70.931.12		15512233	K970R		
460.262B	K141S	70.141.19		M-2349	K126W	70.126.23		15512234	KH901L		
460.264B	K76F	70.076.06		M-2350	K121G			15512235	K901L	70.901.12	
460.266B	K80G			M-2351	K120W			15512239	KG931R	77.931.18	
460.286B	K122E	70.122.05		M-2352	KH901L			15521976	K58G	70.058.07	
460.456B	K120H			M-2353	K535M			15522020	K56G	70.056.07	
460.480B	K56G	70.056.07		M-2358	K971R			15536398	K55G	70.055.07	
460.512C	K146E	70.146.05		M-2363	K70D			15584763	K56G	70.056.07	
460.518C	K981R	70.981.18		M-2370	K55G	70.055.07		15585841	KH931L	78.931.12	
460.523B	K120A			M-2373	K309I	70.309.09		15618118	KG931R	77.931.18	
460.532C	K70R	70.070.18		M-2375	KE350F			19243453	K180E	70.180.05	
460.534B	K147E	70.147.05		M-2378	K125W	70.125.23	50.125.23	85106184	K122E	70.122.05	
460.536C	K103S	70.103.19		M-2379	K310I	70.310.09		88911967	K56G	70.056.07	
460.538	K120A			M-2380	K140I	70.140.09		88911968	K56G	70.056.07	
460.539B	K120A			M-2381	K931L	70.931.12		88911998	K120G		
460.542N	K536M			M-2382	K120E	70.120.05		88936011	K80R	70.080.18	
BLUEBIRD				M-2383	K121E	70.121.05		88936044	K961L	70.961.12	
00063311				M-2384	K102I	70.102.09		88936084	K60R		
00063312				M-2385	K961L	70.961.12		88936119	K70R	70.070.18	
00063313				M-2386	K109I			88936144	KG931R	77.931.18	
2137305	K931L	70.931.12		M-2387	K140I	70.140.09		94058104	K68Z	70.068.26	
2156784	K140I	70.140.09		M-2388	K51G			97723802	K69Z	70.069.26	
2599033	K931L	70.931.12		M-2389	K120E	70.120.05		97782770	K69Z	70.069.26	
4279568	KG931R	77.931.18		M-2390	K121E	70.121.05		98438973	K69Z	70.069.26	

KING PIN KIT INTERCHANGE

PART NO.	QWIKKIT	PLUSKIT	ECONO KIT
CHEVROLET / GMC CONT.			
98441181	K69Z	70.069.26	
98443583	K69Z	70.069.26	
98443939	K69Z	70.069.26	
98448583	K68Z	70.068.26	
IC-2-40	K170G		
DANA / NAPA			
101KK100	K101I	70.101.09	50.101.09
101KK111	K102I	70.102.09	
120KK100	K120I	70.120.09	
120KK102	K146S		
262-1012	K51G		
262-1016	K51G		
262-1017	K70G	70.070.07	
262-1018	K70F		
262-1331	K51G		
262-1336	K98I	70.098.09	50.098.09
262-1364	K125G		
262-1414	KD901R	74.901.18	
262-1421	K70D		
262-1422	K125G		
262-1425	KD901R	74.901.18	
262-1431	K70D		
262-1443	K120W		
262-1461	K50F	70.053.06	
262-1462	K70G	70.070.07	
262-1463	K51G		
262-1464	K901L	70.901.12	
262-1468	K970R	70.970.18	
262-1472	K51G		
262-1473	K70G	70.070.07	
262-1475	K51G		
262-1476	K70F		
262-1482	K901L	70.901.12	
262-1483	K70F		
262-1488	K970R		
262-1490	K109I		
262-1491	K140I	70.140.09	
262-1506	K970R		
262-1507	K901L	70.901.12	
262-1508	K140I	70.140.09	
262-1509	K109I		
262-1510	KD901R	74.901.18	
262-1512	KH901L		
262-1513	KH901L		
262-1514	K970R		
262-1515	K70F		
262-1525	K921L	70.921.12	
262-1537	K75F	70.075.06	
262-1547	K55G	70.055.07	
262-1548	K55G	70.055.07	
262-1549	KE350F		
262-1550	K941F	70.941.06	
262-1551	K95F		
262-1554	KH931L	78.931.12	
262-1555	K101I	70.101.09	50.101.09
262-1556	K941FA		
262-1557	K108I		
262-1558	K139I	70.139.09	
262-1559	K139I	70.139.09	
262-1560	K309I	70.309.09	
262-1561	K309I	70.309.09	
262-1562	K140I	70.140.09	
262-1563	KE350F		
262-1569	K533M	70.533.13	

PART NO.	QWIKKIT	PLUSKIT	ECONO KIT
DANA / NAPA CONT.			
262-1570	K535M		
262-1572	K931L	70.931.12	
262-1574	K121G		
262-1576	K126W	70.126.23	
262-1577	K125W	70.125.23	50.125.23
262-1578	K98I	70.098.09	50.098.09
262-1579	K310I	70.310.09	
262-1580	K971R		
262-1582	K121G		
262-1583	KG931R	77.931.18	
262-1584	K140I	70.140.09	
262-1585	K120E	70.120.05	
262-1586	K121E	70.121.05	
262-1587	K71F		
262-1588	K56G	70.056.07	
262-1590	KH931L	78.931.12	
262-1591	K616M	70.616.13	
262-1592	K931L	70.931.12	
262-1593	K931L	70.931.12	
262-1594	K180E	70.180.05	
262-1597	K72F		
262-1598	K942F	70.942.06	
262-1599	K96F		
262-1600	K941F	70.941.06	
262-1601	K941F	70.941.06	
262-1603	K102I	70.102.09	
262-1604	K961L	70.961.12	
262-1605	K109I		
262-1606	K140I	70.140.09	
262-1608	K51G		
262-1609	K120E	70.120.05	
262-1610	K121E	70.121.05	
262-1611	K56G	70.056.07	
262-1632	K71F		
262-1633	K180E	70.180.05	
262-1634	K961L	70.961.12	
262-1635	K120I	70.120.09	
262-1636	K141S	70.141.19	
262-1637	K76F	70.076.06	
262-1638	K942FA		
262-1639	K146F		
262-1640	K80G		
262-1641	K110G		
262-1642	K120G		
262-1682	K121G		
343KK103	K140I	70.140.09	
429-4716	K146S		
DAYTON			
300-101A	K120H		
300-107	K51G		
300-110	K98I	70.098.09	50.098.09
300-125	K125G		
300-129	K40F	70.040.06	50.040.06
300-135	K50D	70.050.04	50.050.04
300-140	K70D		
300-141	K70D		
300-142	K120W		
300-148	K535M		
300-150	K125G		
300-152	K51G		
300-153	K70G	70.070.07	
300-154	K70G	70.070.07	
300-155	K50F	70.053.06	
300-156	K50F	70.053.06	

PART NO.	QWIKKIT	PLUSKIT	ECONO KIT
DAYTON CONT.			
300-158	KD901R	74.901.18	
300-159	KD901R	74.901.18	
300-160	KD901R	74.901.18	
300-161	KD901R	74.901.18	
300-170	K70D		
300-171	K901L	70.901.12	
300-172	K70G	70.070.07	
300-173	K70G	70.070.07	
300-174	K51G		
300-175	K51G		
300-176	K51G		
300-177	K51G		
300-179	K70F		
300-180	K70F		
300-182	K901L	70.901.12	
300-187	K109I		
300-194	K109I		
300-195	K970R		
300-196	K970R		
300-204	K921L	70.921.12	
300-205	K140I	70.140.09	
300-206	K140I	70.140.09	
300-207	K75F	70.075.06	
300-208	K55G	70.055.07	
300-209	K55G	70.055.07	
300-210	KH901L		
300-211	KH901L		
300-214	KE350F		
300-215	K95F		
300-216	KH931L	78.931.12	
300-217	K941F	70.941.06	
300-218	K101I	70.101.09	50.101.09
300-220	K108I		
300-221	K139I	70.139.09	
300-222	K139I	70.139.09	
300-223	K309I	70.309.09	
300-224	K309I	70.309.09	
300-227	K941FA		
300-228	KE350F		
300-230	K535M		
300-231	K533M	70.533.13	
300-232	K931L	70.931.12	
300-233	K121G		
300-234	K125W	70.125.23	50.125.23
300-235	K126W	70.126.23	
300-240	K971R		
300-242	K931L	70.931.12	
300-244	KG931R	77.931.18	
300-245	K616M	70.616.13	
300-248	K310I	70.310.09	
300-249	K140I	70.140.09	
300-250	K139I	70.139.09	
300-255	K70D		
300-257	K120E	70.120.05	
300-258	K121E	70.121.05	
300-259	K56G	70.056.07	
300-260	K72F		
300-261	K941F	70.941.06	
300-262	K942F	70.942.06	
300-263	K96F		
300-264	KG931R	77.931.18	
300-265	KH931L	78.931.12	
300-266	K961L	70.961.12	
300-267	K180E	70.180.05	

PART NO.	QWIKKIT	PLUSKIT	ECONO KIT
DAYTON CONT.			
300-268	K102I	70.102.09	
300-269	K140I	70.140.09	
300-270	K108I		
300-271	K120I	70.120.09	
300-273	K71F		
300-274	K120E	70.120.05	
300-275	K121E	70.121.05	
300-276	K120I	70.120.09	
300-277	K141S	70.141.19	
300-278	K160S	70.160.19	
300-279	K56G	70.056.07	
300-280	K941F	70.941.06	
300-281	K942FA		
300-282	K102I	70.102.09	
300-283	K180E	70.180.05	
300-284	K961L	70.961.12	
300-285	K71F		
300-286	K76F	70.076.06	
300-287	K80G		
300-288	K110G		
300-289	K120G		
300-290	K122V		
300-291	K140V		
300-292	K146F		
300-293	K122E	70.122.05	
300-294	K146E	70.146.05	
300-295	K146E	70.146.05	
300-296	K70D		
300-297	K122E	70.122.05	
300-298	K146S		
300-299	K981R	70.981.18	
300-300	K942F	70.942.06	
300-303	K123E	70.123.05	
300-305	K147E	70.147.05	
300-306	K147E	70.147.05	
300-307	K146E	70.146.05	
300-310	K180R	70.180.18	
300-312	KH946R	78.946.18	
300-314	K70R	70.070.18	
300-316	K80R	70.080.18	
300-317	K981R	70.981.18	
300-318	K103S	70.103.19	
300-319	K103S	70.103.19	
300-324	K941R	70.941.18	
300-325	K180E	70.180.05	
300-329	K181R	70.181.18	
300-330	K181R	70.181.18	
300-332	KG931R	77.931.18	
300-334	K120R	70.120.18	
300-336			
308-216	KH931L	78.931.12	
308-217	K941F	70.941.06	
308-231	K533M	70.533.13	
308-232	K931L	70.931.12	
308-249	K140I	70.140.09	
308-262	K942F	70.942.06	
308-264	KG931R	77.931.18	
308-268	K102I	70.102.09	
308-274	K120E	70.120.05	
308-276	K120I	70.120.09	
308-277	K141S	70.141	

KING PIN KIT INTERCHANGE

PART NO.	QWIKKIT	PLUSKIT	ECONO KIT
EATON TOP SPEC CONT.			
KP3010	K126W	70.126.23	
KP3011	K139I	70.139.09	
KP3012	K140I	70.140.09	
KP3014	K170G		
KP3019	K309I	70.309.09	
KP3020	K310I	70.310.09	
KP3023	KE350F	75.350.06	
KP3026	K533M	70.533.13	
KP3028	K535M		
KP3030	K616M	70.616.13	
KP3032	K901L	70.901.12	
KP3033	KD901R	74.901.18	
KP3034	KH901L		
KP3035	K921L	70.921.12	
KP3037	K941F	70.941.06	
KP3038	K931L	70.931.12	
KP3039	KH931L	78.931.12	
KP3040	K970R		
KP3041	K971R		
KP3130	K120E	70.120.05	
KP3133	KG931R	77.931.18	
KP3134	K56G	70.056.07	
ELGIN			
KB325	K140I	70.140.09	
KB325N	K140I	70.140.09	
KB424	K109I		
KB425	K109I		
KB425CB	K109I		
KB450	K125G		
KB450A	K125G		
KB450AN	K125G		
KB458CB	K941F	70.941.06	
KB462B	K51G		
KB465A	KD901R	74.901.18	
KB465AN	KD901R	74.901.18	
KB477A	K70D		
KB477AN	K70D		
KB477ANR	K70D		
KB477AR	K70D		
KB479X	K120W		
KB491A	K51G		
KB491AN	K51G		
KB492	K70G	70.070.07	
KB492A	K70G	70.070.07	
KB492AN	K70G	70.070.07	
KB493	K50F	70.053.06	
KB504	K901L	70.901.12	
KB504N	K901L	70.901.12	
KB505A	K970R		
KB505AN	K970R		
KB516	K109I		50.109.09
KB525	KE350F		
KB534B	K921L	70.921.12	
KB537	K75F	70.075.06	
KB546	K95F		
KB547	KH931L	78.931.12	
KB547CB	KH931L	78.931.12	
KB548	K941F	70.941.06	
KB571	K70F		
KB571N	K70F		
KB571NR	K70F		
KB571R	K70F		
KB578	K71F		
KB645	K101I	70.101.09	50.101.09

PART NO.	QWIKKIT	PLUSKIT	ECONO KIT
ELGIN CONT.			
KB700	KH901L		
KB700N	KH901L		
KB722	K55G	70.055.07	
KB722CB	K55G	70.055.07	
KB722N	K55G	70.055.07	
KB816	K108I		
KB817	K139I	70.139.09	
KB817N	K139I	70.139.09	
KB818	K309I	70.309.09	
KB818N	K309I	70.309.09	
KB819	K941FA		
KB819CB	K941FA		
KB823	K931L	70.931.12	
KB825	KE350F		
KB828	K535M		
KB829BI	K533M	70.533.13	
KB830	K121G		
KB832	K125W	70.125.23	50.125.23
KB834	K616M	70.616.13	
KB835	K310I	70.310.09	
KB835	K310I	70.310.09	
KB836	KG931R	77.931.18	
KB836CB	KG931R	77.931.18	
KB837	K971R		
KB838	K126W	70.126.23	
KB839	K931L	70.931.12	
KB839CB	K931L	70.931.12	
KB840	K140I	70.140.09	
KB840CB	K140I	70.140.09	
KB841CB	K120E	70.120.05	
KB842CB	K121E	70.121.05	
KB843	K72F		
KB843CB	K72F		
KB844	K942F	70.942.06	
KB844CB	K942F	70.942.06	
KB845	K96F		
KB846CB	K180E	70.180.05	
KB847	K102I	70.102.09	
KB847CB	K102I	70.102.09	50.102.09
KB848CB	K961L	70.961.12	
KB849	K120I	70.120.09	
KB852	K110G		
KB861	K146E	70.146.05	
KB864	K942FA		
KB868	K147E	70.147.05	
EUCLID			
E-10104B	K80G		
E-10105B	K110G		
E-10106B	K120G		
E-10107B	K180E	70.180.05	
E-10165N	K122V		
E-10166N	K140V		
E-11394B	K122E	70.122.05	
E-11785	K160S	70.160.19	
E-11808C	K981R	70.981.18	
E-11812C	K80R	70.080.18	
E-11813C	K180R	70.180.18	
E-11814C	K181R	70.181.18	
E-11816C	K70R	70.070.18	
E-14051C	K200R		
E-4430B	K51G		
E-4431B	K98I	70.098.09	50.098.09
E-4434B	K125G		
E-4434N	K125G		
E-4438B	K70D		

PART NO.	QWIKKIT	PLUSKIT	ECONO KIT
EUCLID CONT.			
E-4438N	K70D		
E-4440B	K50F	70.053.06	
E-4441B	KD901R	74.901.18	
E-4441N	KD901R	74.901.18	
E-4442B	K901L	70.901.12	
E-4442N	K901L	70.901.12	
E-4443B	K70G	70.070.07	
E-4443N	K70G	70.070.07	
E-4444B	K51G		
E-4444N	K51G		
E-4445B	K70F		
E-4445N	K70F		
E-4446B	K109I		
E-4448B	K109I		
E-4449B	K970R		
E-4449N	K970R		
E-4450B	K921L	70.921.12	
E-4451B	K140I	70.140.09	
E-4451N	K140I	70.140.09	
E-4452B	K75F	70.075.06	
E-4453B	K55G	70.055.07	
E-4453N	K55G	70.055.07	
E-4454B	KH901L		
E-4454N	KH901L		
E-4457B	K95F		
E-4458B	KH931L	78.931.12	
E-4458C	KH931L	78.931.12	
E-4459B	K941F	70.941.06	
E-4459C	K941F	70.941.06	
E-4460B	K101I	70.101.09	50.101.09
E-4461B	K108I		
E-4462B	K139I	70.139.09	
E-4462N	K139I	70.139.09	
E-4463B	K309I	70.309.09	
E-4463N	K309I	70.309.09	
E-4464B	K941FA		
E-4466B	K535M		
E-4467B	K533M	70.533.13	
E-4468B	K931L	70.931.12	
E-4469B	K121G		
E-4470B	K125W	70.125.23	50.125.23
E-4471B	K126W	70.126.23	
E-4595B	K971R		
E-4598B	K120W		
E-4599B	K616M	70.616.13	
E-4693B	K140I	70.140.09	
E-4694C	K931L	70.931.12	
E-4695C	KG931R	77.931.18	
E-4696B	K120E	70.120.05	
E-4696C	K120E	70.120.05	
E-4697B	K310I	70.310.09	
E-4698B	K139I	70.139.09	
E-5485B	K72F		
E-6194B	K180E	70.180.05	
E-6195B	K72F		
E-6196B	K942F	70.942.06	
E-6197B	K96F		
E-6198B	K102I	70.102.09	
E-6199B	K961L	70.961.12	
E-6199C	K961L	70.961.12	
E-6450B	KE350F		
E-6451B	KE350F		
E-6454B	K56G	70.056.07	
E-6455B	K71F		

PART NO.	QWIKKIT	PLUSKIT	ECONO KIT
EUCLID CONT.			
E-6868B	KG931R	77.931.18	
E-6869B	K121E	70.121.05	
E-6869C	K121E	70.121.05	
E-6875C	K140I	70.140.09	
E-6876C	K108I		
E-9312B	K901L	70.901.12	
E-9941B	K120I	70.120.09	
E-9942B	K141S	70.141.19	
E-9943B	K76F	70.076.06	
E-9944B	K942F	70.942.06	
E-9945B	K146F		
FLAGG			
FKP-100-C	KG931R	77.931.18	
FKP-101-C	K121E	70.121.05	
FKP-102-C	K56G	70.056.07	
FKP-103-B	K71F		
FKP-104-B	K72F		
FKP-105-B	K942F	70.942.06	
FKP-106-B	K96F		
FKP-107-C	K941F	70.941.06	
FKP-108-C	K941F	70.941.06	
FKP-109-B	K180E	70.180.05	
FKP-110-B	K102I	70.102.09	
FKP-111-B	K961L	70.961.12	
FKP-111-C	K961L	70.961.12	
FKP-112-B	K108I		
FKP-113-C	K140I	70.140.09	
FKP-114-B	K51G		
FKP-115-B	K120E	70.120.05	
FKP-116-B	K121E	70.121.05	
FKP-117-B	K56G	70.056.07	
FKP-118-B	K120I	70.120.09	
FKP-119-B	K141S	70.141.19	
FKP-11-B	K125G		
FKP-120-B	K76F	70.076.06	
FKP-121-B	K80G		
FKP-122-B	K110G		
FKP-123-B	K120G		
FKP-124B	K146F		
FKP-125-C	K942F	70.942.06	
FKP-126-C	K122V		
FKP-127-C	K140V		
FKP-128-C	K942F	70.942.06	
FKP-129-B	K942FA		
FKP-130-B	K160S	70.160.19	
FKP-130-C	K160S	70.160.19	
FKP-131-B	K122E	70.122.05	
FKP-132-B	K146E	70.146.05	
FKP-133-C	K146E	70.146.05	
FKP-134-C	K146S		
FKP-135-C	K139I	70.139.09	
FKP-136-C	K981R	70.981.18	
FKP-137-B	K126W	70.126.23	
FKP-139-B	K123E	70.123.05	
FKP-140-C	KH946R	78.946.18	
FKP-141-C	K180R	70.180.18	
FKP-142-C	K80R	70.080.18	
FKP-143-C	K70R	70.070.18	
FKP-144-B	K147E	70.147.05	
FKP-145-C	K103S	70.103.19	
FKP-146-C	K941R	70.941.18	
FKP-152-C	K160S	70.160.19	
FKP-153-B	K122E	70.122.05	
FKP-155-B	K72F		

PART NO.	QWIKKIT	PLUSKIT	ECONO KIT
FLAGG CONT.			
FKP-157-C	K60R		
FKP-158-C	K181R	70.181.18	
FKP-34-B	K70F		
FKP-36-B	K50F	70.053.06	
FKP-37-B	K901L	70.901.12	
FKP-38-B	K51G		
FKP-39-B	K70G	70.070.07	
FKP-40-B	K51G		
FKP-43-B	K70F		
FKP-44-B	K109I		
FKP-46-B	K70D		
FKP-49-B	K970R		
FKP-4-B	K51G		
FKP-50-B	K901L	70.901.12	
FKP-51-B	K109I		
FKP-52-B	KH901L	78.901.12	
FKP-53-B	KD901R	74.901.18	
FKP-54-B	K70F		
FKP-59-B	K120W		
FKP-62-B	K921L	70.921.12	
FKP-68-B	K140I	70.140.09	
FKP-69-B	K75F	70.075.06	
FKP-70-B	K55G	70.055.07	
FKP-71-B	KH931L	78.931.12	
FKP-72-B	K941F	70.941.06	
FKP-73-B	K95F		
FKP-74-B	KE350F		
FKP-75-B	K101I	70.101.09	50.101.09
FKP-76-B	K108I		
FKP-77-B	K139I	70.139.09	
FKP-78-B	K309I	70.309.09	
FKP-79-B	K941FA		
FKP-81-B	KE350F		
FKP-82-B	K98I	70.098.09	50.098.09
FKP-84-B	K535M		
FKP-85-B	K533M	70.533.13	
FKP-86-B	K121G		
FKP-88-B	K126W	70.126.23	
FKP-89-B	K125W	70.125.23	50.125.23
FKP-8-B	K98I	70.098.09	50.098.09
FKP-90-B	K931L	70.931.12	
FKP-91-B	K310I	70.310.09	
FKP-92-B	KG931R	77.931.18	
FKP-93-B	K971R</		

KING PIN KIT INTERCHANGE

PART NO.	QWIKKIT	PLUSKIT	ECONO KIT
FLEETRITE CONT.			
FAK4590	K941F	70.941.06	
FAK4594	K56G	70.056.07	
FAK4596	K180E	70.180.05	
FAK4598	K141S	70.141.19	
FAK4599	K76F	70.076.06	
FAK4600	K80G		
FAK4601	K120I	70.120.09	
FAK4603	K146F		
FAK4604	K110G		
FAK4605	K120G		
FAK4606	K942F	70.942.06	
FAK4609	K160S	70.160.19	
FAK4610	K122E	70.122.05	
FAK4614	K981R	70.981.18	
FAK4626	K103S	70.103.19	
FAK5444	K101I	70.101.09	50.101.09
FAK5446	K139I	70.139.09	
FAK5447	K309I	70.309.09	
FAK5451	K310I	70.310.09	
FAK5452	K101I	70.101.09	50.101.09
FAK5453	K140I	70.140.09	
FAK5454	K102I	70.102.09	
FAK5455	K120I	70.120.09	
FAK5456	K141S	70.141.19	
FAK5457	K160S	70.160.19	
FAK5459	K536M		
FAK5465	K120I	70.120.09	
FAK5466	K141S	70.141.19	
FAK5500	K147E	70.147.05	
FAK5506	K122E	70.122.05	
FAK5507	K147E	70.147.05	
FORD			
2C2Z-3111AA	K50W		
4C40-3010-RA	K103S	70.103.19	
4C40-3111BA	K103S	70.103.19	
4C4Z-3111AA	K120I	70.120.09	
4C4Z-3111AB	K141S	70.141.19	
4C4Z-3111BB	K103S	70.103.19	
4C4Z-3111CA	K120I	70.120.09	
B7QH-3111A	KD901R	74.901.18	
B7QH-3111B	K70D		
B7TZ-3111B	K70D		
B7TZ-3111C	K125G		
B7TZ-3111D	KD901R	74.901.18	
B7TZ-3111F	K70D		
B7TZ-3111G	KD901R	74.901.18	
B7Y-3111A	K40F	70.040.06	50.040.06
B8QH-3111B	K125G		
BC4Z-3111D	K961L	70.961.12	
BC4Z-3111E	K80R	70.080.18	
C1TZ-3111C	K125G		
C2TZ-3111B	K70D		
C2TZ-3111C	KD901R	74.901.18	
C2TZ-3111D	K125G		
C2TZ-3111F	K70D		
C2TZ-3111G	KD901R	74.901.18	
C3TZ-3111A	K50F	70.053.06	
C3TZ-3111B	K901L	70.901.12	
C3TZ-3111C	K901L	70.901.12	
C3TZ-3111D	K50F	70.053.06	
C4TA-3010C	K50F	70.053.06	
C4TA-3010E	K50F	70.053.06	
C4TZ-3111A	K970R		
C4TZ-3111B	K970R		

PART NO.	QWIKKIT	PLUSKIT	ECONO KIT
FORD CONT.			
C5TZ-3111B	KH901L		
C5TZ-3111D	KH901L		
C7HZ-3111A	K70F		
C7TA-3010J	K70F		
C7TA-3010Z	KD901R	74.901.18	
C7TZ-3111A	K70F		
C9TA-3010D	K50F	70.053.06	
C9TZ-3111C	K901L	70.901.12	
DOHA-3010H	K901L	70.901.12	
D0HZ-3111A	KD901R	74.901.18	
D0HZ-3111B	K901L	70.901.12	
D0HZ-3111C	K970R		
D0HZ-3111E	KH901L		
D1HT-3111B	K901L	70.901.12	
D1HZ-3010AA	KH901L		
D1HZ-3111A	KD901R	74.901.18	
D1HZ-3111B	K901L	70.901.12	
D1HZ-3111C	K901L	70.901.12	
D1TZ-3111C	K901L	70.901.12	
D2TZ-3111D	K50F	70.053.06	
D3HA-3010AA	KH931F	78.931.06	
D3HA-3010KA	KH931F	78.931.06	
D3TZ-3111A	K70F	70.070.06	50.070.06
D5HZ-3111C	KH931F	78.931.06	
D5TZ-3111B	K75F	70.075.06	
D5UZ-3111B	KE350F		
D5UZ-3111D	KE350F		
D6HZ-3111A	K941F	70.941.06	
D6HZ-3111B	K95F		
D6HZ-3111C	K941F	70.941.06	
D6HZ-3111D	K95F		
D6TZ-3111A	K75F	70.075.06	
D7HT-3010RA	K941F	70.941.06	
D7HT-3010UA	K50F	70.053.06	
D7HZ-3111A	KD901R	74.901.18	
D7TZ-3111A	K70F		
D8HZ-3111C	K941FA		
EOHT-3010AC	K70F		
EOHT-3010CA	K75F	70.075.06	
E0TZ-3111A	KE350F		
E2HT-3010AA	K901L	70.901.12	
E2HT-3010BA	K941F	70.941.06	
E2HT-3010DA	K942FA		
E4HT-3010CB	K75F	70.075.06	
E7HT-3010AA	K95F		
E7HT-3010BA	K95F		
E7HT-3010EA	K941F	70.941.06	
E7HT-3010HA	K70F		
E7HT-3010SA	KH931F	78.931.06	
E7HT-3010TA	K942F	70.942.06	
E7HZ-3010S	K942F	70.942.06	
E7TZ-3111A	K75F	70.075.06	
E8HZ-3111A	K72F		
E8TA-3010A2C	K71F		
E8TZ-3111A	K71F		
E9HT-3010AA	K942F	70.942.06	
E9HT-3010EA	K70F		
E9HZ-3111A	K942F	70.942.06	
E9HZ-3111B	K96F		
E9HZ-3111C	K76F	70.076.06	
FOHT-3010AA	KH931F	78.931.06	
FOHT-3010BA	K96F		
FOHT-3010CA	K72F		
FOHT-3010DA	K72F		

PART NO.	QWIKKIT	PLUSKIT	ECONO KIT
FORD CONT.			
FOHT-3010EA	K76F	70.076.06	
FOHT-3010FA	K76F	70.076.06	
FOHT-3010SA	K76F	70.076.06	
FOHZ-3111A	K942F	70.942.06	
F1HT-3010AA	K942F	70.942.06	
F1HZ-3010A	K76F	70.076.06	
F1HZ-3010C	K76F	70.076.06	
F1HZ-3111A	K72F		
F2HT-3010AA	K942F	70.942.06	
F4HZ-3010D	K942F	70.942.06	
F5HT-3010BA	K72F		
F5HT-3010DA	K942F	70.942.06	
F5HT-3010EA	K942F	70.942.06	
F5HT-3010GA	KH931F	78.931.06	
F5HT-3010HA	KH931F	78.931.06	
F5HT-3010JA	KH931F	78.931.06	
F5HZ-3111A	K146F		
F6HT-3010AB	KH931F	78.931.06	
F6HT-3010BA	K942F	70.942.06	
F6HT-3010BB	K942F	70.942.06	
F6HT-3010DB	K942F	70.942.06	
F6HZ-3111AA	K942F	70.942.06	
F6HZ-3111BB	K942F	70.942.06	
F6HZ-3111CC	K942FA		
F6HZ-3111DB	K942F	70.942.06	
F81-3010AA	K72F		50.942.06
F81A-3010CA	K76F	70.076.06	50.076.06
F81D-3010AA	K72F		
F81Z-3010AA	K72F		
F81Z-3010CA	K76F	70.076.06	
L7HT-3010EA	K941F	70.941.06	
FREIGHTLINER			
123	K125G		
144	K125G		
156	K970R		
157	K970R		
167	K901L	70.901.12	
168	KH901L		
170	KH901L		
172	K901L	70.901.12	
195	K931L	70.931.12	
198	KH931L	78.931.12	
199	K921L	70.921.12	
1300	K971R		
1303	K971R		
1307	K931L	70.931.12	
1320	K71D		
P6073300019KZ	K120A		
P6073300119KZ	K120A		
P6073300219KZ	K80A		
P6073300319KZ	K80A		
P6073300419KZ	K160A		
P6073300519KZ	K160A		
GILLIG			
82-11863-000	KG931R	77.931.18	
82-206-3800	KG931R	77.931.18	
82-283305	KH946R	78.946.18	
82-33422-000	K122E	70.122.05	
82-90285-000	KH946R	78.946.18	
HD PLUS			
HKP2025	K98I	70.098.09	50.098.09
HKP2030	K125G		
HKP2065	K50F	70.053.06	
HKP2070	K901L	70.901.12	

PART NO.	QWIKKIT	PLUSKIT	ECONO KIT
HD PLUS CONT.			
HKP2075	K51G		
HKP2080	K70G	70.070.07	
HKP2090	K51G		
HKP2095	K70F		
HKP2110	K70F		
HKP2115	K970R		
HKP2120	K901L	70.901.12	
HKP2125	KH901L		
HKP2130	KH901L		
HKP2135	KH901L		
HKP2160	K921L	70.921.12	
HKP2180	K140I	70.140.09	
HKP2185	K75F	70.075.06	
HKP2190	K55G	70.055.07	
HKP2200	KH931L	78.931.12	
HKP2205	K941F	70.941.06	
HKP2210	K95F		
HKP2220	K101I	70.101.09	50.101.09
HKP2230	K108I		
HKP2235	K139I	70.139.09	
HKP2245	K309I	70.309.09	
HKP2250	K941FA		
HKP2270	K931L	70.931.12	
HKP2275	K535M		
HKP2280	K533M	70.533.13	
HKP2285	K126W	70.126.23	
HKP2295	KG931R	77.931.18	
HKP2300	KG931R	77.931.18	
HKP2305	K971R		
HKP2310	K121G		
HKP2315	K140I	70.140.09	
HKP2320	K120E	70.120.05	
HKP2335	K121E	70.121.05	
HKP2340	K616M	70.616.13	
HKP2345	K102I	70.102.09	
HKP2350	K961L	70.961.12	
HKP2355	K72F		
HKP2360	K96F		
HKP2365	K942F	70.942.06	50.942.06
HKP2370	K70D		
HKP2375	K120E	70.120.05	
HKP2380	K121E	70.121.05	
HKP2390	K310I	70.310.09	
HKP2400	K56G	70.056.07	
HKP2635	K70D		
HKP2640	K120W		
HKP2660	K125G		
HKP2665	K70G	70.070.07	
HKP2670	K70G	70.070.07	
HKP2685	KD901R	74.901.18	
HKP2690	KD901R	74.901.18	
HKP2730	K70D		
HKP2735	K70G	70.070.07	
HKP2740	K51G		
HKP2745	K51G		
HKP2750	K51G		
HKP2815	K970R		
HKP2840	K140I	70.140.09	
HKP2855	K55G	70.055.07	
HKP2860	KH901L		
HKP2875	K101I	70.101.09	50.101.09
HKP2880	K101I	70.101.09	50.101.09
HKP2885	K102I	70.102.09	
HKP2890	K108I		

PART NO.	QWIKKIT	PLUSKIT	ECONO KIT
HD PLUS CONT.			
HKP2895	K139I	70.139.09	
HKP2900	K139I	70.139.09	
HKP2905	K139I	70.139.09	
HKP2910	K309I	70.309.09	
HKP2915	K309I	70.309.09	
HKP2930	K931L	70.931.12	
HKP2935	K125W		
HKP2945	K121G		
HKP2950	K310I	70.310.09	
HKP2955	K310I	70.310.09	
HKP2970	KD901R	74.901.18	
HKP2975	K931L	70.931.12	
HKP2995	KH931L	78.931.12	
HKP3000	K941F	70.941.06	
HKP3005	K180E	70.180.05	
HKP3010	K180E	70.180.05	
HKP3015	K102I	70.102.09	
HKP3025	K961L	70.961.12	
HKP3030	K961L	70.961.12	
HKP3040	K108I		
HKP3045	K941FA		
HKP3050	K120I	70.120.09	
HKP3055	K120I	70.120.09	
HKP3060	K141S	70.141.19	
HKP3065	K942FA		
HKP3070	K76F	70.076.06	
HKP3080	K120E	70.120.05	
HKP3085	K121E	70.121.05	
HKP3090	K146F		
HKP3095	K180E	70.180.05	
HKP3100	K80G		
HKP3105	K110G		
HKP3110	K120G		
HKP3125	K141S	70.141	

KING PIN KIT INTERCHANGE

PART NO.	QWIKKIT	PLUSKIT	ECONO KIT
MERITOR			
17110	KG931R	77.931.18	
17111	KG931R	77.931.18	
R200001	K51G		
R200003	K98I	70.098.09	50.098.09
R200017	K120W		
R200018	K50F	70.053.06	
R200024	K70G	70.070.07	
R200025	K70G	70.070.07	
R200026	K51G		
R200027	K51G		
R200028	K70F		
R200029	K70F	70.073.06	
R200031	K109I		
R200034	K109I		
R200042	K140I	70.140.09	
R200043	K140I	70.140.09	
R200044	K75F	70.075.06	
R200045	K55G	70.055.07	
R200046	K55G	70.055.07	
R200049	KE350F		
R200050	K95F		
R200051	K941F	70.941.06	
R200052	K101I	70.101.09	50.101.09
R200054	K108I		
R200055	K139I	70.139.09	
R200056	K139I	70.139.09	
R200057	K309I	70.309.09	
R200058	K309I	70.309.09	
R200061	K941FA		
R200062	KE350F		
R200064	K533M		
R200065	K533M	70.533.13	
R200066	K121G		
R200067	K125W	70.125.23	50.125.23
R200068	K126W	70.126.23	
R200071	K616M	70.616.13	
R200073	K310I	70.310.09	
R200074	K140I	70.140.09	
R200075	K139I	70.139.09	
R200121	K170G		
R200123	K125G		
R200138	KD901R	74.901.18	
R200142	KD901R	74.901.18	
R200143	K70D		
R200144	K125G		
R200145	K170G		
R200152	K125G		
R200154	KD901R	74.901.18	
R200155	K70D		
R200156	K970R		
R200157	K970R		
R200163	K901L	70.901.12	
R200167	K901L	70.901.12	
R200168	KH901L		
R200170	KH901L		
R200172	K901L	70.901.12	
R200174	K109I		
R200184	KD901R	74.901.18	
R200186	K125G		
R200188	K970R		
R200189	KH901L		
R200190	K901L	70.901.12	
R200191	KH901L		
R200193	K921L	70.921.12	

PART NO.	QWIKKIT	PLUSKIT	ECONO KIT
MERITOR CONT.			
R200195	K931L	70.931.12	
R200198	KH931L	78.931.12	
R200199	K921L	70.921.12	
R200250	K180E	70.180.05	
R200251	K121E	70.121.05	
R200267	K120E	70.120.05	
R200268	K102I	70.102.09	
R200269	K120E	70.120.05	
R200270	K121E	70.121.05	
R200271	K51G		
R200272	K72F		
R200273	K942F	70.942.06	50.942.06
R200274	K941F	70.941.06	
R200275	K96F		
R200276	K941F	70.941.06	
R200277	K108I		
R200278	K140I	70.140.09	
R200279	K160S	70.160.19	
R200280	K76F	70.076.06	
R200281	K122E	70.122.05	
R200282	K80G		
R200283	K110G		
R200284	K120G		
R200285	KH931L	78.931.12	
R2002916	K127W	70.127.23	
R200300	K56G	70.056.07	
R201300	K971R		
R201303	K970R		
R201307	K931L	70.931.12	
R201309	KG931R	77.931.18	
R201310	KG931R	77.931.18	
R201312	KH931L	78.931.12	
R201314	K70D		
R201315	K961L	70.961.12	
R201318	K941R	70.941.18	
R201319	KG931R	77.931.18	
R201320	K71D		
R201326	K122E	70.122.05	
R201327	K147E	70.147.05	
R201334	K123E	70.123.05	
R201370	K931L	70.931.12	
R201419	K981R	70.981.18	
R201420	KH946R	78.946.18	
R201424	KH946R	78.946.18	
R201425	KG931R	77.931.18	
R201426	K120I	70.120.09	
R201427	K141S	70.141.19	
R201470	K961L	70.961.12	
R201471	KG931R	77.931.18	
R201472	K981R	70.981.18	
R201473	K120R	70.120.18	
R201474	K80R	70.080.18	
R201475	K180R	70.180.18	
R201476	K181R	70.181.18	
R201477	KH931L	78.931.12	
R201478	K60R		
R201479	K70R	70.070.18	
R201482	K200R		
R201483	K70R	70.070.18	
R201484	K80R	70.080.18	
R201488			
R201490	K981R	70.981.18	
R201600	K56G	70.056.07	
R201601	K71F	70.071.06	

PART NO.	QWIKKIT	PLUSKIT	ECONO KIT
MERITOR CONT.			
R201602	K56G	70.056.07	
R201604	K80R	70.080.18	
R201605	K80R	70.080.18	
R201606	K80R	70.080.18	
R201607	K180R	70.180.18	
R201608	K131R		
R201609	K130R		
R202001	K122E	70.122.05	
R202002	K961L	70.961.12	
R202003	K981R	70.981.18	
R202004	K120I	70.120.09	
R202005	K102I	70.102.09	
R202006	K147E	70.147.05	
R202007	K120E	70.120.05	
R202008	KH946R	78.946.18	
R202009	K103S	70.103.19	
R202010	KG931R	77.931.18	
R202011	KH931L	78.931.12	
R202012	K80R	70.080.18	
R202014	K931L	70.931.12	
R202015	K533M	70.533.13	
R202018	K146E	70.146.05	
R202019	K180E	70.180.05	
R202020	K141S	70.141.19	
R202021	K70R	70.070.18	
R202026	K616M	70.616.13	
R202027	K110G		
R202029	K120G		
R202030	K181R	70.181.18	
R202031	K180R	70.180.18	
R202032	K122E	70.122.05	
R202033	K123E	70.123.05	
R202034	K201S		
R202035	K536M		
R202036	K80A		
R202037	K120A		
R202038	K160A		
R202039	K121E	70.121.05	
R202040	K120R	70.120.18	
R202041	KH931L	78.931.12	
R202042	KG931R	77.931.18	
R202043	KG931R	77.931.18	
R202044	KH931L	78.931.12	
R202045	K70R	70.070.18	
R202046	K80R	70.080.18	
R202047	K981R	70.981.18	
R202048	K80R	70.080.18	
R202049	K80R	70.080.18	
R202050	K80R	70.080.18	
R202051			
R202052			
R202053			
MITSUBISHI			
MC992486	K60U		
MK703748	K60U		
MOOG			
8343B	K51G		
8355B	K98I	70.098.09	50.098.09
8375B	K98I	70.098.09	50.098.09
8375T	K98I	70.098.09	50.098.09
8386B	K125G		
8386N	K125G		
8460B	KD901R	74.901.18	
8460N	KD901R	74.901.18	

PART NO.	QWIKKIT	PLUSKIT	ECONO KIT
MOOG CONT.			
8464B	K51G		
8467	K70D		
8476B	K120W		
8478B	K535M		
8479B	K70D		
8479N	K70D		
8483B	K970R		
8483N	K970R		
8484T	K51G		
8486T	K70G	70.070.07	
8488B	K50F	70.053.06	
8489B	K901L	70.901.12	
8489N	K901L	70.901.12	
8490T	K51G		
8491B	K70G	70.070.07	
8491N	K70G	70.070.07	50.070.07
8492B	K51G		
8492N	K51G		
8493N	K70F		
8500B	K70F		
8500F	K70F		
8500N	K70F		
8502B	K109I		
8504B	KD901R	74.901.18	
8507B	K70D		
8507N	K70D		
8509B	KE350F		
8514B	K970R		
8514N	K970R		
8515B	K901L	70.901.12	
8515N	K901L	70.901.12	
8518B	KH901L		
8518N	KH901L		
8519B	KD901R	74.901.18	
8519N	KD901R	74.901.18	
8520B	K70F		
8525B	K50F	70.053.06	
8527B	K120W		
8536B	K125G		
8536N	K125G		
8553B	K921L	70.921.12	
8567B	K140I	70.140.09	
8567N	K140I	70.140.09	
8568B	K75F	70.075.06	
8570B	K55G	70.055.07	
8570N	K55G	70.055.07	
8571B	KH931L	78.931.12	
8571C	KH931L	78.931.12	
8572B	K941F	70.941.06	
8572C	K941F	70.941.06	
8573B	K95F		
8574B	KE350F		
8577B	K101I	70.101.09	50.101.09
8578B	K70D		
8579B	K108I		
8581B	K139I	70.139.09	
8581N	K139I	70.139.09	
8583B	K309I	70.309.09	
8583N	K309I	70.309.09	
8585B	K941FA		
8585C	K941FA		
8589B	KE350F		
8590B	K931L	70.931.12	
8591B	K98I	70.098.09	50.098.09

PART NO.	QWIKKIT	PLUSKIT	ECONO KIT
MOOG CONT.			
8591N	K98I	70.098.09	50.098.09
8593B	K535M		
8600B	K110G		
8601B	K533M	70.533.13	
8603B	K121G		
8605B	K126W	70.126.23	
8607B	K125W	70.125.23	50.125.23
8609B	K50F	70.053.06	
8610B	K310I	70.310.09	
8611B	K931L	70.931.12	
8611C	K931L	70.931.12	
8612B	K971R		
8613B	K121G		
8615B	K616M	70.616.13	
8616C	K931L	70.931.12	
8617B	K140I	70.140.09	
8618C	K120E	70.120.05	
8627B	K56G	70.056.07	
8627C	K56G	70.056.07	
8629C	K71F	70.071.06	
8631C	K121E	70.121.05	
8633C	K180E	70.180.05	
8635C	KG931R	77.931.18	
8637B	K102I	70.102.09	
8639B	K72F		
8641B	K96F		
8643B	K942F	70.942.06	50.942.06
8645B	K108I		
8647B	K120E	70.120.05	
8653B	K76F	70.076.06	
8655B	K120I	70.120.09	
8659B	K80G		
8660B	K110G		
8661B	K120G		
80063B	K961L	70.961.12	
80074B	K160S	70.160.19	
80076B	K122E	70.122.05	
80077B	K146E	70.146.05	
NAVISTAR			
151007R91	KD901R	74.901.18	
155932R92	K125G		
1648204C91	K101I	70.101.09	50.101.09
1651921C91	K120E	70.120.05	
1658394C91	K3		

KING PIN KIT INTERCHANGE

PART NO.	QWIKKIT	PLUSKIT	ECONO KIT
NEW STAR S & S			
S-3596	K108I		
S-3682	K55G	70.055.07	
S-4483	K120I	70.120.09	
S-4948	K139I	70.139.09	
S-4949	K309I	70.309.09	
S-4988	K140I	70.140.09	
S-4996	K98I	70.098.09	50.098.09
S-5134	K310I	70.310.09	
S-5223	K101I	70.101.09	50.101.09
S-6072	K533M	70.533.13	
S-6073	K616M	70.616.13	
S-6485	K120E	70.120.05	
S-6486	K121E	70.121.05	
S-6488	K70F		
S-6492	K70D		
S-6494	K70F		
S-6501	KE350F		
S-6502	K941F	70.941.06	
S-6503	K95F		
S-6504	K75F	70.075.06	
S-6634	K51G		
S-6635	K70G	70.070.07	
S-6643	K121G		
S-6663	K109I		
S-6938	KD901R	74.901.18	
S-6939	K125G		
S-6942	K970R		
S-6943	K970R		
S-6944	K901L	70.901.12	
S-6945	KH901L		
S-6946	KH901L		
S-6947	K901L	70.901.12	
S-6948	K931L	70.931.12	
S-6949	KH931L	78.931.12	
S-6950	K921L	70.921.12	
S-6963	K971R		
S-6964	K931L	70.931.12	
S-6965	KG931R	77.931.18	
S-7190	K120W		
S-7191	K126W	70.126.23	50.126.13
S-7463	K140I	70.140.09	
S-7721	K70G	70.070.07	
S-7801	K140I	70.140.09	
S-8371	K120E	70.120.05	
S-8513	KG931R	77.931.18	
S-8529	KH931L	78.931.12	
S-8678	K961L	70.961.12	
S-9304	K102I	70.102.09	
S-9365	K180E	70.180.05	
S-9722	K55G	70.055.07	
S-A482	K102I	70.102.09	
S-A483	K120I	70.120.09	
S-A484	K141S	70.141.19	
S-A811	K120I	70.120.09	
S-C119	K981R	70.981.18	
S-C464	K122E	70.122.05	
S-D562	K122E	70.122.05	
S-D819	K120G		
S-F091	K80G		
S-F092	K110G		
S-F187	K180E	70.180.05	
OTTAWA			
90013937	K961L	70.961.12	

PART NO.	QWIKKIT	PLUSKIT	ECONO KIT
PETERBILT			
123	K125G		
144	K125G		
156	K970R		
157	K970R		
167	K901L	70.901.12	
168	KH901L		
170	KH901L		
172	K901L	70.901.12	
195	K931L	70.931.12	
198	KH931L	78.931.12	
199	K921L	70.921.12	
1300	K971R		
1303	K971R		
RIDEWELL			
1660106	KG931R	77.931.18	
16673258034	K127W	70.127.23	
SEALED POWER			
808-391C	K51G		
808-401N	K98I	70.098.09	50.098.09
808-477	K70D		
808-479	K120W		
808-489	K125G		
808-492	K70G	70.070.07	
808-493	K50F	70.053.06	
808-496	KD901R	74.901.18	
808-496B	KD901R	74.901.18	
808-503	K70D		
808-504	K901L	70.901.12	
808-506	K70G	70.070.07	
808-506B	K70G	70.070.07	
808-507	K51G		
808-507B	K51G		
808-509	K70F		
808-509B	K70F		
808-510B	K901L	70.901.12	
808-516	K109I		
808-524B	K109I		
808-526B	K970R		
808-526D	K970R		
808-534B	K921L	70.921.12	
808-535B	K140I	70.140.09	
808-535D	K140I	70.140.09	
808-538	K75F	70.075.06	
808-538B	K75F	70.075.06	
808-539	K55G	70.055.07	
808-539D	K55G	70.055.07	
808-540B	K55G	70.055.07	
808-541B	KH901L		
808-542D	KH901L		
808-545B	KE350F		
808-546B	K95F		
808-547B	KH931L	78.931.12	
808-548B	K941F	70.941.06	
808-549B	K101I	70.101.09	50.101.09
808-551B	K108I		
808-552B	K139I	70.139.09	
808-553D	K139I	70.139.09	
808-554B	K309I	70.309.09	
808-555D	K309I	70.309.09	
808-558B	K941F	70.941.06	
808-559B	KE350F		
808-561B	K535M		
808-562B	K533M	70.533.13	
808-563B	K931L	70.931.12	

PART NO.	QWIKKIT	PLUSKIT	ECONO KIT
SEALED POWER CONT.			
808-564B	K126W	70.126.23	
808-565B	K125W	70.125.23	50.125.23
808-567B	K121G		
808-570B	K971R		
SPICER			
328342	K122E	70.122.05	
328343	K146E	70.146.05	
328344	K122E	70.122.05	
328345	K146E	70.146.05	
328346	K123E	70.123.05	
328347	K147E	70.147.05	
328348	K123E	70.123.05	
328349	K147E	70.147.05	
329022	K141S	70.141.19	
329023	K160S	70.160.19	
329182	K103S	70.103.19	
329404	K146E	70.146.05	
329405	K146E	70.146.05	
329432	K180E	70.180.05	
329433	K180E	70.180.05	
331434	K200S		
331435	K201S		
503700	K145E		
503701	K147E	70.147.05	
524530	K146E	70.146.05	
806355	K120E	70.120.05	
811525	K180E	70.180.05	
815984	K120E	70.120.05	
101KK100	K101I	70.101.09	50.101.09
101KK109	K101I	70.101.09	50.101.09
101KK110	K101I	70.101.09	50.101.09
101KK111	K102I	70.102.09	
101KK113	K101I	70.101.09	50.101.09
120KK100	K120I	70.120.09	
120KK102	K146S		
140KK100	K141S	70.141.19	
151KK101	K160S	70.160.19	
161KK100	K161S		
220KK100	K160S	70.160.19	
220KK300	K201S		
309KK102	K310I	70.310.09	
309KK103	K310I	70.310.09	
309KK105	K140I	70.140.09	
337KK100	K309I	70.309.09	
337KK101	K139I	70.139.09	
337KK103	K309I	70.309.09	
337KK104	K139I	70.139.09	
343KK100	K140I	70.140.09	
KPK1001			
KPK1002	K120A		
KPK1003	K120A		
KPK1004	K160A		
KPK1005	K160A		
KPK1008	K70D		
KPK1009			
KPK1010			
KPK1011			
KPK1012			
KPK1013			
KPK1014			
KPK1015			
KPK1017			
KPK1018			
KPK1019			

PART NO.	QWIKKIT	PLUSKIT	ECONO KIT
SPICER CONT.			
KPK1020	K170G		
KPK1021			
KPK1022			
KPK1023			
KPK1024	K981R	70.981.18	
KPK1025	K70F		
KPK1026	K70F		
KPK1027			
KPK1028			
KPK1029	K70D		
KPK1030			
KPK1031			
KPK1032			
KPK1033			
KPK1034			
KPK1035			
KPK1037			
KPK1038	KH946R	78.946.18	
KPK1039			
KPK1040			
KPK1041			
KPK1042			
KPK1043			
KPK1044			
KPK1045			
KPK1046			
KPK1047			
KPK1048			
KPK1049			
KPK1050			
KPK1051			
KPK1052			
KPK1053			
KPK1054			
KPK1055			
KPK1056			
KPK1057			
KPK1058			
KPK1059			
KPK1060			
KPK1061			
KPK1062			
KPK1063			
KPK1064			
KPK1065			
KPK1066			
KPK1067			
KPK1068	K80R	70.080.18	70.080.18
KPK1069			
KPK1070			
KPK1071			
KPK1072			
KPK1073	K55G	70.055.07	
KPK1075	K55G	70.055.07	
KPK1076			
KPK1077			
KPK1078			
KPK1079			
KPK1080	K56G	70.056.07	
KPK1081			
KPK1082	K56G	70.056.07	
KPK1083			
KPK1084			
KPK1085			

PART NO.	QWIKKIT	PLUSKIT	ECONO KIT
SPICER CONT.			
KPK1086			
KPK1087			
KPK1088			
KPK1089			
KPK1092			
KPK1093			
KPK1094			
KPK1095			
KPK1096			
KPK1097			
KPK1098			
KPK1099			
KPK1100			
KPK1101			
KPK1102			
KPK1103			
KPK1104			
KPK1105			
KPK1106	K533M	70.533.13	
KPK1107			
KPK1108			
KPK1109			
KPK1110			
KPK1111			
KPK1112			
KPK1113			
KPK1114			
KPK1115			
KPK1116	KH931L	78.931.12	
KPK1117	K931L	70.931.12	
KPK1118	KG931R	77.931.18	
KPK1119	K931L	70.931.12	
KPK1120	KG931R	77.931.18	
KPK1121	KH931L	78.931.12	
KPK1122	K961L	70.961.12	
KPK1123	K961L	70.961.12	
KPK1124			
KPK1125			
KPK1126			
KPK1127			
KPK1128			
KPK1129			
KPK1130			
KPK1131			
KPK1132			
KPK1133			
KPK1134			
KPK1135			
KPK1136			
KPK1137			
KPK1138			
KPK1139			
KPK1140			
KPK1141			
KPK1142			
KPK1143			
KPK1144			
KPK1145			
KPK1146			
KPK1147			
KPK1148			
KPK1149			
KPK1150			

PART NO.	QWIKKIT	PLUSKIT	ECONO KIT
SPICER CONT.			
KPK1151	K941R	70.941.18	50.941.08
KPK1152			
KPK1153			
KPK1154	K102I	70.102.09	
KPK1155	K120I	70.120.09	
KPK1156	K120E	70.120.05	
KPK1157	K180E	70.180.05	
KPK1158	K141S	70.141.19	
KPK1159	K160S	70.160.19	
KPK1160			
KPK1161	K103S	70.103.19	
K			

KING PIN KIT INTERCHANGE

PART NO.	QWIKKIT	PLUSKIT	ECONO KIT
STEERING (SPIRAL) CONT.			
SKS12205	K122E	70.122.05	
SKS12523	K125W	70.125.23	50.125.23
SKS12623	K126W	70.126.23	
SKS12723	K127W	70.127.23	
SKS13023	K130W	70.130.23	
SKS13108	K131H		
SKS14119	K141S	70.141.19	
SKS14605	K146E	70.146.05	
SKS14705	K147E	70.147.05	
SKS14905	K149E		
SKS18005	K180E	70.180.05	
SKS18118	K181R	70.181.18	
SKS53313	K533M	70.533.13	
SKS53613	K536M		
SKS61613	K616M	70.616.13	
SKS7018	K70R	70.070.18	
SKS8018	K80R	70.080.18	
SKS8123	K81W		
SKS93112	K931L	70.931.12	
SKS94118	K941R	70.941.18	
SKS96112	K961L	70.961.12	
SKS98118	K981R	70.981.18	
STEMCO KAISER			
	K101I	70.101.09	50.101.09
	K102I	70.102.09	
	K103S	70.103.19	
	K108I		
	K109I		
	K120E	70.120.05	
	K120I	70.120.09	
	K120R	70.120.18	
	K121E	70.121.05	
	K121G		
	K122E	70.122.05	
	K123E	70.123.05	
	K125G		
	K125W	70.125.23	50.125.23
	K126W	70.126.23	
	K127W	70.127.23	
	K130W	70.130.23	50.123.23
	K139I	70.139.09	
	K140I	70.140.09	
	K141S	70.141.19	
	K146E	70.146.05	
	K147E	70.147.05	
	K160S	70.160.19	
	K180E	70.180.05	
	K180R	70.180.18	
	K181R	70.181.18	
	K309I	70.309.09	
	K310I	70.310.09	
	K50F	70.053.06	
	K533M	70.533.13	
	K55G	70.055.07	
	K56G	70.056.07	
	K616M	70.616.13	
	K68Z	70.068.26	
	K69Z	70.069.26	
	K70D		
	K70F		
	K70G	70.070.07	
	K70R	70.070.18	
	K71D		
	K71F		

PART NO.	QWIKKIT	PLUSKIT	ECONO KIT
STEMCO KAISER CONT.			
	K72F		
	K75F	70.075.06	
	K76F	70.076.06	
	K80R	70.080.18	
	K901L	70.901.12	
	K921L	70.921.12	
	K931L	70.931.12	
	K941F	70.941.06	
	K941R	70.941.18	
	K942F	70.942.06	50.942.06
	K95F		
	K961L	70.961.12	
	K96F		
	K970R		
	K981R	70.981.18	
	K98I	70.098.09	50.098.09
	KD901R	74.901.18	
	KE350F		
	KG931R	77.931.18	
	KH901L		
	KH931F	78.931.06	
	KH931L	78.931.12	
	KH946R	78.946.18	
THOMAS BUS			
8314171	K102I	70.102.09	
1307	K931L	70.931.12	
1309	KG931R	77.931.18	
1310	KG931R	77.931.18	
P6073300019KZ	K120A		
P6073300119KZ	K120A		
TRAYER / ROAD LEVELER			
TK257	K98I	70.098.09	50.098.09
TK331	K51G		
TK331B	K51G		
TK336	K98I	70.098.09	50.098.09
TK422	K125G		
TK443	K120W		
TK461	K50F	70.053.06	
TK462	K70G	70.070.07	
TK463	K51G		
TK464	K901L	70.901.12	
TK472	K51G		
TK472B	K51G		
TK473	K70G	70.070.07	
TK473B	K70G	70.070.07	
TK475	K51G		
TK480	K70D		
TK481	K70D		
TK482	K901L	70.901.12	
TK483	K70F		
TK483B	K70F		
TK490	K109I		
TK496	KD901R	74.901.18	
TK497	K70D		
TK498	K70D		
TK506	K970R		
TK507	K901L	70.901.12	
TK509	K970R		
TK510	KD901R	74.901.18	
TK512	KH901L		
TK513	KH901L		
TK514	K970R		
TK515	K70F		
TK525	K921L	70.921.12	

PART NO.	QWIKKIT	PLUSKIT	ECONO KIT
TRAYER / ROAD LEVELER CONT.			
TK537	K75F	70.075.06	
TK538	KH931L	78.931.12	
TK539	K941F	70.941.06	
TK540	K95F		
TK541	K55G	70.055.07	
TK541B	K55G	70.055.07	
TK542	KE350F		
TK546	K101I	70.101.09	50.101.09
TK546B	K101I	70.101.09	50.101.09
TK547	K941FA		
TK548	K108I		
TK549	K139I	70.139.09	
TK549B	K139I	70.139.09	
TK550	K309I	70.309.09	
TK550B	K309I	70.309.09	
TK551	K931L	70.931.12	
TK553	KE350F		
TK554B	K98I	70.098.09	50.098.09
TK556	K535M		
TK557	K533M	70.533.13	
TK558	K121G		
TK560	K125W	70.125.23	50.125.23
TK561	K126W	70.126.23	
TK562	K50F	70.053.06	
TK566	K616M	70.616.13	
TK567	K310I	70.310.09	
TK567B	K310I	70.310.09	
TK568	KG931R	77.931.18	
TK569	K931L	70.931.12	
TK570	K971R		
TK571	K140I	70.140.09	
TK589	K120E	70.120.05	
TK590	KH931L	78.931.12	
TK592	K56G	70.056.07	
TK594	K71F		
TK596	K121E	70.121.05	
TK597	K72F		
TK598	K942F	70.942.06	50.942.06
TK599	K96F		
TK600	K941F	70.941.06	
TK601	K941F	70.941.06	
TK602	K180E	70.180.05	
TK603	K102I	70.102.09	
TK603B	K102I	70.102.09	
TK604	K961L	70.961.12	
TK605	K108I		
TK606	K140I	70.140.09	
TK608	K51G		
TK609	K120E	70.120.05	
TK610	K121E	70.121.05	
TK611	K56G	70.056.07	
TK613	K70D		
TK614	K70G	70.070.07	
TK616	K70D		
TK624	K70G	70.070.07	
TK626	K103S	70.103.19	
TK632	K71F		
TK633	K180E	70.180.05	
TK634	K961L	70.961.12	
TK635	K120I	70.120.09	
TK635B	K120I	70.120.99	
TK636	K141S	70.141.19	
TK637	K76F	70.076.06	
TK638	K942FA		

PART NO.	QWIKKIT	PLUSKIT	ECONO KIT
TRAYER / ROAD LEVELER CONT.			
TK640	K80G		
TK641	K110G		
TK642	K120G		
TK645	K102I	70.102.09	
TK646	K120I	70.120.09	
TK652	K122E	70.122.05	
TK653	K180E	70.180.05	
TK654	K146E	70.146.05	
TK716	K122E	70.122.05	
TK750	K536M		
TRW			
K391C	K51G		
K391N	K51G		
K401N	K98I	70.098.09	50.098.09
K450	K125G		
K465	KD901R	74.901.18	
K477	K70D		
K479	K120W		
K482	K70D		
K487	K535M		
K487B	K535M		
K489	K125G		
K491	K51G		
K491N	K51G		
K492	K70G	70.070.07	
K493	K50F	70.053.06	
K494	K970R		
K496	KD901R	74.901.18	
K496B	KD901R	74.901.18	
K503	K70D		
K504	K901L	70.901.12	
K505	K970R		
K505B	K970R		
K506	K70G	70.070.07	
K506B	K70G	70.070.07	
K507	K51G		
K507B	K51G		
K508	K70F		
K509	K70F		
K509B	K70F		
K510B	K901L	70.901.12	
K516	K109I		
K523B	K140I	70.140.09	
K524B	K109I		
K526B	K970R		
K526D	K970R		
K534B	K921L	70.921.12	
K535B	K140I	70.140.09	
K535D	K140I	70.140.09	
K536B	K70G	70.070.07	
K538B	K75F	70.075.06	
K539D	K55G	70.055.07	
K540B	K55G	70.055.07	
K541B	KH901L		
K542D	KH901L		
K545B	KE350F		
K546B	K95F		
K547B	KH931L	78.931.12	
K548B	K941F	70.941.06	
K549B	K101I	70.101.09	50.101.09
K551B	K108I		
K552B	K139I	70.139.09	
K553D	K139I	70.139.09	
K554B	K309I	70.309.09	

PART NO.	QWIKKIT	PLUSKIT	ECONO KIT
TRW CONT.			
K555D	K309I	70.309.09	
K558B	K941FA		
K559B	KE350F		
K561B	K535M		
K562B	K533M	70.533.13	
K563B	K931L	70.931.12	
K564B	K125W	70.125.23	50.125.23
K565B	K126W	70.126.23	
K567B	K121G		
K570B	K971R		
K571B	K310I	70.310.09	
K572B	K140I	70.140.09	
K574B	K616M	70.616.13	
K576C	K931L	70.931.12	
K577C	K56G	70.056.07	
K578B	K71F		
K582	KG931R	77.931.18	
K583	KG931R	77.931.18	
K584			

KING PIN KIT INTERCHANGE

PART NO.	QWIKKIT	PLUSKIT	ECONO KIT
WATSON CHALIN			
SRK98	K130W	70.130.23	
SRK102	K961L	70.961.12	
SRK103	K941R	70.941.18	
SRK105	KH931L	78.931.12	
SRK112	K130W	70.130.23	
SRK115	K81W		
SRK120	K181R	70.181.18	
WESTERN STAR			
195	K931L	70.931.12	
198	KH931L	78.931.12	
1307	K931L	70.931.12	
217175	K125W	70.125.23	50.125.23
WESTERN STAR CONT.			
806355	K120E	70.120.05	
37090-5000	K931L	70.931.12	
37090-5002	KG931R	77.931.18	
37090-5005	K126W	70.126.23	
37090-5015	K971R		
37090-5018	K931L	70.931.12	
37090-5019	KG931R	77.931.18	
37090-5022	KH931L	78.931.12	
WESTPORT			
143698-0001	K125W	70.125.23	50.125.23
143698-0002	K126W	70.126.23	
143698-0018	K181R	70.181.18	
143698-0024	K95F		
143698-0029	K127W	70.127.23	
143698-0040	K72F	70.072.06	
143698-0051	K126W	70.126.23	
143698-0052	K127W	70.127.23	
143698-0053	K96F		
143698-0063	K127W	70.127.23	
1637090-4405	K126W	70.126.23	
WORKHORSE			
8003056	K50W		
8007225	K50W		
8006372	K58G	70.058.07	
8007232	K72F		
8803050	K56G	70.056.07	

BEARING INTERCHANGE

SUPPLIER	STEMCO KAISER
T110	701.4.9
T119	701.4.14
T126	701.4.4
T1260S	701.4.34
T1370	701.4.23
T139	701.4.15
T139S	701.4.35
T149	701.4.5
T1490S	701.4.36
T163	701.4.1
T1760	701.4.18
T1795P	701.4.31
T182	701.4.2
T1822S	701.4.30
T18294S	701.4.28
T182S	701.4.27
T1880	701.4.3
T188S	701.4.25
T189	701.4.24
T1910	701.4.19
T1920	701.4.17
T1921	701.4.20
T194S	701.4.21
T195S	701.4.22
T202	701.4.29
T208	701.4.11
T208S	701.4.37
T2165P	701.4.32
528548B1	701.4.26

SHIM PACK CROSS REFERENCE SHEET

INDIVIDUAL SHIM NUMBER	10 PACK NUMBER	THICKNESS	OUTSIDE DIAMETER	INSIDE DIAMETER	KIT REFERENCE (TOP 10)
80P1-1	SP1-1	0.005	2.87	1.63	K139I, K140I, K95F, K96F, K971R, 70.139.09, 70.140.09, 70.095.06, 70.096.06
80P1-12	SP1-12	0.005	2.50	1.33	K71F, K72F, 50.071.06, 70.071.06, 70.072.06
80P1-14	SP1-14	0.005	2.62	1.65	K120E, K121E, 70.120.05, 70.121.05
80P1-2	SP1-2	0.005	2.81	1.87	K122E, K126W, K127W, K931L, K961L, KG931R, KH946R, 70.122.05, 70.961.12
80P1-21	SP1-21	0.005	1.94	1.20	K50W, K55G, K565G, K58G, K68Z, K69Z, 50.055.07, 70.055.07, 70.056.07, 70.058.07
80P1-22	SP1-22	0.005	2.24	1.39	K101I, K102I, K103S, 50.101.09, 70.101.09, 70.102.09, 70.103.19
80P1-23	SP1-23	0.005	3.60	2.14	K120I, K141S, K160A, K160S, K161S, 70.120.09, 70.141.19, 70.160.19
80P1-24	SP1-24	0.005	3.00	1.90	K120H, K146E, K147E, 70.146.05, 70.146.05
80P1-26	SP1-26	0.005	1.61	1.32	K80G
80P1-30	SP1-30	0.005	3.75	2.27	K700T
80P1-5	SP1-5	0.005	2.50	1.50	K170G, K75F, K76F, KD901R, 70.075.06, 70.076.06, 74.901.18
80P1-9	SP1-9	0.005	3.25	2.03	K180E, K180R, K181R, KH901L, KH931L, 78.931.12, 70.180.05, 78.901.12, 78.931.12
80P2-1	SP2-1	0.010	2.00	1.31	K50F, K70D, K70F, K70G, K71D, 70.053.06, 70.073.06, 70.070.07, 70.071.04
80P2-10	SP2-10	0.010	2.50	1.33	K71F, K72F, 50.071.06, 70.071.06, 70.072.06
80P2-11	SP2-11	0.010	2.62	1.65	K120E, K121E, 70.120.05, 70.121.05
80P2-15	SP2-15	0.010	2.50	1.81	K120R, K981R, 70.981.18
80P2-17	SP2-17	0.010	1.94	1.20	K55G, K56G, K58G, K68Z, K69Z, 50.055.07, 70.055.07, 70.056.07, 70.058.07
80P2-18	SP2-18	0.010	2.24	1.39	K101I, K102I, K103S, 50.101.09, 70.101.09, 70.102.09, 70.103.19
80P2-19	SP2-19	0.010	3.60	2.14	K120I, K140S, K160S, K161S, 50.140.19, 70.120.09, 70.140.19, 70.160.19
80P2-2	SP2-2	0.010	2.50	1.50	K170G, K75F, K76F, KD901R, 70.075.06, 70.076.06, 74.901.18
80P2-20	SP2-20	0.010	3.00	1.90	K120H, K146E, K147E, 70.146.05, 70.146.05
80P2-21	SP2-21	0.010	2.50	1.52	K70R, K80R, K941R, 70.070.18, 70.080.18, 70.941.18
80P2-24	SP2-24	0.010	1.95	1.25	K60R
80P2-27	SP2-27	0.010	3.75	2.27	K700T, 70.700.20
80P2-3	SP2-3	0.010	1.75	1.15	K51G
80P2-5	SP2-5	0.010	2.81	1.87	K122E, K126W, K127W, K931L, K961L, KG931R, KH946R, 70.122.05, 70.961.12
80P2-7	SP2-7	0.010	3.25	2.03	K180E, K180R, K181R, KH901L, KH931L, 78.931.12, 70.180.05, 78.901.12, 78.931.12
80P2-8	SP2-8	0.010	2.00	1.15	KE350F, 5.350.06, 50.050.04, 75.300.06, 70.050.04
80P2-9	SP2-9	0.010	2.31	1.22	K95G, 50.095.07, 70.095.07
80P3-24	SP3-24	0.030	2.81	1.87	K80A, K120A, K122E, K123E, K123K, 70.122.05, 70.123.05
80P3-26	SP3-26	0.015	1.89	1.60	K110G, K120G
80P3-29	SP3-29	0.030	3.25	2.03	K180E, K180R, K181R, KH901L, KH931L, 78.931.12, 70.180.05, 78.901.12, 78.931.12
80P3-31	SP3-31	0.030	3.00	1.90	K120H, K146E, K147E, 70.146.05, 70.146.05

SHIM PACK CROSS-REFERENCE SHEET

AUG 2017

01 577 0083

KIT REF.	K101I		K102I		K103S		K108I		K109I		K110G		K120A		K120E		K120G		
PART REF.	QTY	PART NO.	QTY	PART NO.	QTY	PART NO.	QTY	PART NO.	QTY	PART NO.	QTY	PART NO.	QTY	PART NO.	QTY	PART NO.	QTY	PART NO.	
KING PIN	2	10M13-1	2	10M37-1	2	10M56-1	2	10M27-1	2	10M14-2	2	10M42-5	2	10M63-1	2	10M24-10	2	10M42-6	
BUSHING	4	20M13-1	4	20M13-1	4	20M13-1	4	20M14-4	4	20M14-4	2	20M18-9	4	32A18-4	4	20M16-8	2	20M18-9	
STEEL LINER																			
TAPER LOCK PINS	2	60M7-1	2	60M4-10	4	60M2-20	2	60M2-11	4	602.4.1			4	60M1-21	2	60M2-15			
			2	60M4-11															
			2	60M7-8															
END PLATE / PLUG	4	401.12.1	4	401.12.1			4	401.3.1	4	401.3.1			4	45P8-4	4	401.127.2			
O-RING GASKET	4	93P1-6	4	93P1-6	4	92P1-28	4	92P1-8	4	92P1-8	2	41P10-2	4	92P1-37	4	92P1-11	2	41P10-2	
BUSHING SEAL	4	91P1-14	4	91P1-14	4	91P1-14	4	91P1-19			2	91P5-2	4	91P1-47	4	91P1-25	2	91P5-2	
											2	91P6-2					2	91P6-2	
BEARING	2	701.4.35	2	701.4.35	2	701.4.35	2	701.4.5	2	701.4.5	2	70P4-4A	1	701.4.31	2	701.4.19	2	70P4-4A	
											2	70P4-4B	1	701.7.1			2	70P4-4B	
BEARING SEAL									2	91P2-15									
SHIM	5	80P1-22	5	80P1-22	5	80P1-22	7	80P1-1	7	80P1-1	6	80P3-26	6	80P2-5	5	80P1-14	6	80P3-26	
	5	80P2-18	5	80P2-18	5	80P2-18						12	80P3-24	5	80P2-11				
CAP SCREW	8	5/16-18X.6	8	5/16-18X.6			12	5/16-18X.7	12	5/16-18X.7						12	5/16-18X1		
NUT	2	50P19-2	2	50P19-2	4	50P19-2	2	50P19-3				4	50P19-1	2	50P19-3				
LOCK WASHER	8	5/16	8	5/16			12	5/16	12	5/16						12	5/16		
FELT WASHER																			
EXPANSION PLUG																			
RELIEF FITTING																			
COTTER PIN																			
LOCK RING													4	100P1-5					
CASTLE NUT												2	50P17-1				2	50P17-1	

KIT REF.	K120H		K120I		K120N		K120R		K120W		K121A		K121E		K121G		K122A		
PART REF.	QTY	PART NO.	QTY	PART NO.	QTY	PART NO.	QTY	PART NO.	QTY	PART NO.	QTY	PART NO.	QTY	PART NO.	QTY	PART NO.	QTY	PART NO.	
KING PIN	2	10M51-2	2	10M38-2	2	10M54-1	2	10M33-3	2	10M18-1	2	10M63-1	2	10M24-10	2	10M21-8	2	10M63-1	
BUSHING	4	20M18-10	4	20M21-11	2	32A18-1	4	20M20-1	2	20M18-1	4	32A18-4	4	20M16-8	2	20M19-7	4	32A18-4	
						2	32A18-2			2	20M18-2				2	20M19-8			
STEEL LINER																			
TAPER LOCK PINS			2	60M2-19			2	60M1-1	2	60M2-1	4	60M2-21	2	60M2-15	2	60M4-7	4	60M2-21	
			2	60M2-20											2	60M4-8			
END PLATE / PLUG	4	45P8-1			4	401.140.1	4	401.128.1	4	401.20.1	4	45P8-4	4	401.127.2	4	401.128.1	4	45P8-4	
O-RING GASKET	4	92P1-17	4	92P1-20	4	92P1-27	4	92P1-4	4	92P1-4	4	92P1-37	4	92P1-11	4	92P1-4	4	92P1-37	
BUSHING SEAL	4	91P1-44	4	91P1-32			4	91P1-29			4	91P1-47	4	91P1-25			4	91P1-47	
BEARING	2	701.4.30	2	701.4.21	2	701.4.26	2	701.4.27	2	701.4.25	2	701.4.31	2	70P2-13	2	701.4.18	2	701.7.1	
BEARING SEAL															2	91P2-9/10			
SHIM	26	80P2-20	6	80P1-23	4	80P1-9	5	80P1-19	7	80P1-2	6	80P2-5	5	80P1-14	5	80P1-2	6	80P2-5	
			6	80P2-19	4	80P2-7	3	80P2-15			12	80P3-24	5	80P2-11	5	80P2-5	12	80P3-24	
			4	80P3-30	6	80P3-32	4	80P3-33											
CAP SCREW	4	5/8-11X1.25	12	5/16-18X1			12	5/16-18X1	12	1/4-20X1/2		12	5/16-18X1	12	5/16-18X.7				
NUT			4	50P19-2			4	50P19-1	2	50P19-1	4	50P19-1	2	50P19-3			4	50P19-1	
LOCK WASHER			12	5/16			12	5/16	12	1/4		12	5/16	12	5/16				
FELT WASHER																			
EXPANSION PLUG																			
RELIEF FITTING					4	90P3-1			4	90P1-1					4	90P1-1			
COTTER PIN																			
LOCK RING	4	103P1-1			4	100P1-9					4	100P1-5			2	100P1-7	4	100P1-5	
CASTLE NUT																			

KIT REF.	K122E		K122V		K123E		K123K		K125G		K125W		K126W		K127W		K130R		
PART REF.	QTY	PART NO.	QTY	PART NO.	QTY	PART NO.	QTY	PART NO.	QTY	PART NO.	QTY	PART NO.	QTY	PART NO.	QTY	PART NO.	QTY	PART NO.	
KING PIN	2	10M35-3	2	9M12-1	2	10M55-2	2	10M35-5	2	9M16-6	2	10M18-2	2	10M18-2	2	10M18-2	2	10M33-5	
BUSHING	4	20M19-9	2	20M24-2	4	20M19-9	4	20M19-9	4	20M16-7	2	20M18-1	2	20M18-1	2	20M18-1	2	20M19-9	
											2	20M18-2	2	20M18-2	2	20M18-2	2	20M19-11	
STEEL LINER																			
TAPER LOCK PINS	2	60M1-9			2	31M18-1			2	31M16-2									
					2	60M1-16	2	60M1-17	2	60M1-23		2	60M2-8	2	60M2-8	2	60M2-8	2	60M1-7
END PLATE / PLUG	4	45P6-1			4	45P6-1	4	45P6-1	2	40P16	4	401.20.1	4	401.20.1	4	45P2-3	2	45P2-3	
																	2	45P17-1	
O-RING GASKET	4	93P1-12	2	92P1-24	4	93P1-12			2	41P4-1	4	92P1-4	4	92P1-4					
			2	92P1-25															
BUSHING SEAL	4	91P1-29	2	91P7-1	4	91P1-29	4	91P1-29	4	91P3-1	4	91P1-44	4	91P1-44	4	91P1-44	4	91P1-29	
			2	91P8-1															
BEARING	2	701.4.2	2	70P4-3	2	701.4.28	2	701.4.2	2	701.4.1	2	701.4.25	2	701.4.17	2	701.4.20	2	701.4.27	
BEARING SEAL																	2	91P2-11	
SHIM	3	80P1-2	2	80P3-25	3	80P1-2	3	80P1-2	5	80P3-3	7	80P1-2	7	80P1-2	7	80P1-2	4	80P1-19	
	5	80P2-5	4	80P3-26	5	80P2-5	5	80P2-5	2	80P3-4	5	80P2-5	5	80P2-5	5	80P2-5	2	80P2-15	
	2	80P3-24	2	80P3-28	2	80P3-24	2	80P3-24	2	80P3-5							2	80P3-33	
									2	80P3-6									
CAP SCREW									6	5/16-18X.5	12	1/4-20X1/2	12	1/4-20X1/2					
NUT	2	50P19-1			4	50P19-2	2	50P19-2			2	50P19-1	2	50P19-1	2	50P19-1	4	50P19-1	
LOCK WASHER									6	5/16	12	1/4	12	1/4					
FELT WASHER																			
EXPANSION PLUG																			
RELIEF FITTING											4	90P1-1	4	90P1-1					
COTTER PIN			2	102P16-3					2	102P16-1									
LOCK RING									2	100P1-2									
CASTLE NUT									2	50P14-1									

KIT REF.	K130W		K131H		K131R		K132K		K139I		K140I		K141V		K141S		K145E		
PART REF.	QTY	PART NO.	QTY	PART NO.	QTY	PART NO.	QTY	PART NO.	QTY	PART NO.	QTY	PART NO.	QTY	PART NO.	QTY	PART NO.	QTY	PART NO.	
KING PIN	2	10M21-3	2	10M18-8	2	10M33-5	2	10M35-5	2	10M24-1	2	10M16-13	2	9M14-1	2	10M38-6	2	10M55-4	
BUSHING	4	20M20-1	4	20M18-10	2	20M19-9	4	20M19-9	4	20M17-1	4	20M17-1	2	20M21-17	4	20M21-10	2	20M18-13	
																	2	20M18-8	
STEEL LINER																			
TAPER LOCK PINS	2	60M1-1	2	60M1-1	2	60M1-1	2	60M1-23	2	60M2-11	4	602.4.1					4	60M2-19	
																	2	60M1-17	
END PLATE / PLUG	4	45P2-3	4	45P8-1	2	45P2-3	4	45P											

KIT REF.	K70F	K70G	K70R	K71D	K71F	K72F	K75F	K75M	K76F
PART REF.	QTY PART NO.	QTY PART NO.	QTY PART NO.	QTY PART NO.	QTY PART NO.	QTY PART NO.	QTY PART NO.	QTY PART NO.	QTY PART NO.
KING PIN	2 10M12-2	2 10M12-1	2 10M52-3	2 10M2-1	2 10M13-6	2 10M37-4	2 10M25-1	2 10M13-7	2 10M25-1
BUSHING	4 20M2-7	4 20M12-1	4 20M15-7	4 20M2-1	4 20M13-4	4 20M13-7	4 20M14-6	4 32A16-12	4 20M14-6
STEEL LINER									
TAPER LOCK PINS	2 60M2-3	2 60M3-1	2 60M1-14	4 602.4.1	2 60M2-17	2 60M1-10	2 60M1-1	2 60P6-1	2 60M1-1
			2 60M1-7		2 60M1-11	2 60M1-2			2 60M1-2
END PLATE / PLUG	4 401.120.3	4 401.12.2		4 401.143.1	4 45P2-4	4 45P2-4	2 401.128.1	4 401.138.1	4 45P2-5
O-RING GASKET	4 93P1-2	4 41P3-1		4 92P1-16			2 92P1-4	4 92P1-23	
BUSHING SEAL			4 91P1-41	4 91P1-43	4 91P1-35	4 91P1-35	4 91P1-16	4 91P1-37	4 91P1-16
BEARING	2 701.4.4	2 701.4.4	2 701.4.5	2 701.4.34	2 70P2-15	2 701.4.23	2 701.4.5	2 70P2-14	2 701.4.5
BEARING SEAL			2 91P2-15					2 91P2-14	
SHIM	5 80P1-4	5 80P1-4	5 80P1-25	5 80P1-4	5 80P1-12	5 80P2-10	5 80P1-5		5 80P1-5
	5 80P2-1	5 80P2-1	5 80P2-21	5 80P2-1	5 80P2-10		5 80P2-2		5 80P2-2
CAP SCREW	8 10-32X5/8	8 1/4-28X1/2		8 5/16-18X3/4			6 5/16-18X3/4		
NUT	2 50P19-1	2 50P19-2	4 50P19-1		2 50P19-1	4 50P19-1	4 50P19-1	2 M10X1.5	4 50P19-1
LOCK WASHER	8 10/32	8 1/2		8 5/16			6 5/16		
FELT WASHER									
EXPANSION PLUG							2 45P1-11		
RELIEF FITTING	4 90P1-3	4 90P1-1					2 90P1-1		
COTTER PIN									
LOCK RING							2 100P1-3	4 100P1-3	
CASTLE NUT									

KIT REF.	K80A	K80G	K80R	K81W	K901L	K921L	K931L	K941F	K941FA
PART REF.	QTY PART NO.	QTY PART NO.	QTY PART NO.	QTY PART NO.	QTY PART NO.	QTY PART NO.	QTY PART NO.	QTY PART NO.	QTY PART NO.
KING PIN	2 10M63-2	2 10M42-4	2 10M52-2	2 10M52-1	2 10M21-1	2 10M21-2	2 10M21-3	2 10M33-2	2 10M33-2
BUSHING	4 32A18-5	2 20M16-11	4 20M15-7	4 20M15-5	4 20M19-5	4 20M20-1	4 20M20-1	4 20M20-1	4 20M20-1
STEEL LINER									
TAPER LOCK PINS	4 60M1-21		2 60M1-14	2 60M1-7	2 60M7-3	2 60M7-3	2 60M1-1	2 60M1-1	2 60M1-1
			2 60M1-7		2 60M7-4	2 60M7-4	2 60M1-2	2 60M1-2	2 60M1-2
END PLATE / PLUG	4 45P8-4			4 45P2-5	2 401.128.1	4 401.128.1	4 401.128.1	4 401.128.1	4 401.128.1
O-RING GASKET	4 92P1-37	2 41P10-1		4 92P1-4	4 92P1-4	4 92P1-4	4 92P1-4	4 92P1-4	4 92P1-4
BUSHING SEAL	4 91P1-47	2 91P5-1	4 91P1-41	4 91P1-41	4 91P1-29	4 91P1-6	4 91P1-29	4 91P1-29	4 91P1-29
		2 91P6-1							
BEARING	1 701.4.31	2 70P4-2A	2 701.4.5	2 701.4.5	2 701.4.2	2 701.4.27	2 701.4.27	2 701.4.2	
	1 701.7.1	2 70P4-2B							
BEARING SEAL			2 91P2-15	2 91P2-15					2 701.4.20
SHIM	6 80P2-5	8 80P1-26	5 80P1-25	2 80P1-25	5 80P1-2	5 80P1-2	5 80P1-2	9 80P1-2	9 80P1-2
	12 80P3-24	4 80P2-22	5 80P2-21	6 80P2-21	8 80P2-5	8 80P2-5	8 80P2-5	9 80P2-5	7 80P2-5
CAP SCREW					6 5/16-18X3/4	12 5/16-18X3/4	12 5/16-18X3/4	12 5/16-18X3/4	12 5/16-18X3/4
NUT	4 50P19-1		4 50P19-1	2 50P19-1	4 50P19-2	4 50P19-2	4 50P19-1	4 50P19-1	4 50P19-1
LOCK WASHER					6 5/16	12 5/16	12 5/16	12 5/16	12 5/16
FELT WASHER									
EXPANSION PLUG								2 45P1-9	
RELIEF FITTING								2 90P1-1	
COTTER PIN									
LOCK RING	4 100P1-5							2 100P1-1	
CASTLE NUT									
		2 50P17-1							

KIT REF.	K941R	K942F	K942FA	K95F	K95G	K961L	K96F	K970R	K971R
PART REF.	QTY PART NO.	QTY PART NO.	QTY PART NO.	QTY PART NO.	QTY PART NO.	QTY PART NO.	QTY PART NO.	QTY PART NO.	QTY PART NO.
KING PIN	2 10M52-1	2 10M33-2	2 10M33-2	2 10M26-1	2 9M16-7	2 10M21-3	2 10M26-1	2 10M16-5	2 10M16-7
BUSHING	4 20M15-5	4 20M20-1	4 20M20-1	4 20M16-7	2 20M14-1	4 20M20-1	4 20M16-7	4 20M16-7	4 20M16-7
					2 20M14-2				
STEEL LINER									
TAPER LOCK PINS	2 60M1-7	2 60M1-1	2 60M1-1	2 60M1-1		2 60M1-7	2 60M1-1	4 602.4.1	4 602.4.1
	2 60M1-14	2 60M1-2	2 60M1-2	2 60M1-2		2 60M1-8	2 60M1-2		
END PLATE / PLUG	4 401.139.1	4 45P2-3	4 45P2-3	2 401.128.1	2 40P16	4 401.128.1	4 45P2-5	2 40M123-1	4 401.128.1
O-RING GASKET	4 92P1-26			2 92P1-4	2 41P4-1	4 92P1-4		2 92P1-8	4 92P1-4
BUSHING SEAL	4 91P1-41	4 91P1-29	4 91P1-29	4 91P3-1		4 91P1-29	4 91P3-1	4 91P3-1	4 91P3-1
BEARING	2 701.4.5	2 701.4.2	2 701.4.20	2 701.4.1	2 701.4.5	2 701.4.27	2 701.4.1	2 701.4.1	2 701.4.1
BEARING SEAL	2 91P2-15								2 91P2-7
SHIM	5 80P2-21	9 80P1-2	9 80P1-2	9 80P1-1	9 80P2-9	5 80P1-2	9 80P1-1	13 80P1-1	7 80P1-1
		7 80P2-5	7 80P2-5		2 80P3-7	8 80P2-5			
					2 80P3-9				
CAP SCREW	12 5/16-18X1			6 5/16-18X3/4	6 1/4-28X1/2	12 5/16-18X3/4		4 5/16-18X3/4	12 5/16-18X3/4
NUT	4 50P19-1	4 50P19-1	4 50P19-1	4 50P19-1		4 50P19-1	4 50P19-1		
LOCK WASHER	12 5/16			6 5/16	6 1/4	12 5/16		4 5/16	12 5/16
FELT WASHER									
EXPANSION PLUG				2 45P1-8	2 45P1-11			2 45P1-8	
RELIEF FITTING				2 90P1-1				2 90P1-3	
COTTER PIN									
LOCK RING					2 102P16-1				
LOCK RING				2 100P1-2	2 100P1-3			2 100P1-2	
CASTLE NUT									
					2 50P14-3				

KIT REF.	K981R	K981	KD901R	KE350F	KG931R	KH901L	KH931F	KH931L	KH946R
PART REF.	QTY PART NO.	QTY PART NO.	QTY PART NO.	QTY PART NO.	QTY PART NO.	QTY PART NO.	QTY PART NO.	QTY PART NO.	QTY PART NO.
KING PIN	2 10M21-12	2 10M12-3	2 10M14-1	2 10M10-3	2 10M21-3	2 10M22-1	2 10M22-2	2 10M22-2	2 10M21-14
BUSHING	4 20M19-9	4 20M12-3	4 20M14-6	4 20M5-2	4 20M20-1	4 20M21-1	4 20M21-2	4 20M21-2	2 20M19-9
									2 20M19-11
STEEL LINER									
TAPER LOCK PINS	2 60M1-7	2 60M7-1	4 602.4.1	2 60M2-3	2 60M1-1	4 60M4-4	2 60M1-3	2 60M1-3	2 60M1-3
	2 60M1-8				2 60M1-2		2 60M1-4	2 60M1-4	2 60M1-4
					2 60M1-8				2 60M1-8
END PLATE / PLUG	4 45P2-3	4 40M120-4	2 401.128.1	2 45P2-2	4 401.128.1	2 401.128.2	4 401.128.2	4 401.128.2	4 45P7-1
O-RING GASKET		4 93P1-1	2 92P1-4		4 92P1-4	2 92P1-9	4 92P1-9	4 92P1-9	
BUSHING SEAL	4 91P1-29		4 91P1-16	4 91P1-23	4 91P1-29		4 91P1-15	4 91P1-15	4 91P1-29
BEARING	2 701.4.27	2 701.4.4	2 701.4.5	2 70P2-3	2 701.4.30	2 701.4.11	2 701.4.11	2 701.4.37	2 701.4.27
BEARING SEAL									
SHIM	5 80P1-19	5 80P1-4	5 80P1-5	5 80P1-10	5 80P1-2	5 80P1-9	5 80P1-9	5 80P1-9	10 80P1-2
	5 80P2-15	5 80P2-1	5 80P2-2	5 80P2-8	8 80P2-5	9 80P2-7	9 80P2-7	9 80P2-7	10 80P2-5
								2 80P3-29	
								2 80P3-34	
CAP SCREW		8 1/4-28X5/8	6 5/16-18X3/4		12 5/16-18X3/4	6 5/16-18X3/4	12 5/16-18X3/4	12 5/16-18X3/4	
NUT	4 50P19-1	2 50P19-2		2 50P19-1	4 50P19-1		4 50P19-1	4 50P19-1	4 50P19-1
LOCK WASHER		8 1/4	6 5/16		12 5/16	6 5/16	12 5/16	12 5/16	
FELT WASHER									
EXPANSION PLUG				2 45P1-11			2 45P1-10		
RELIEF FITTING		4 90P1-3	2 90P1-1				2 90P1-1		
COTTER PIN									
LOCK RING				2 100P1-13			2 100P1-5		
CASTLE NUT									

KIT REF.	70.053.06	70.055.07	70.056.07	70.058.07	70.068.26	70.069.26	70.070.07	70.070.18	70.071.96
PART REF.	QTY PART NO.	QTY PART NO.	QTY PART NO.	QTY PART NO.	QTY PART NO.	QTY PART NO.	QTY PART NO.	QTY PART NO.	QTY PART NO.
KING PIN	2 105.50.3	2 105.11.10	2 105.11.10	2 105.11.10	2 105.58.1	2 105.58.1	2 105.12.1	2 105.52.3	2 105.13.6
BUSHING	4 202.2.3	4 202.11.7	4 202.11.10	4 202.11.10	4 202.11.12	4 202.11.12	4 202.12.1	4 202.15.7	4 202.13.6
STEEL LINER									
TAPER LOCK PINS	2 60M2-3	2 60M1-15	2 60M1-15	2 60M1-15	2 60M2-23	2 60M2-23	2 60M3-1	2 60M1-14	2 60M2-17
							2 60M1-7		
END PLATE / PLUG				4 401.141.1	2 45P9-1	2 45P9-1		4 45P2-4	
O-RING GASKET	4 92P1-19	4 41P3-6	4 41P3-6	4 41P3-6	2 92P1-29	2 92P1-29	4 41P3-1		
BUSHING SEAL		4 91P1-45	4 91P1-42	4 91P1-42	2 91P9-1	2 91P9-1	4 91P1-41	4 91P1-35	
BEARING	2 701.4.4	2 701.4.14	2 701.4.14	2 701.4.14	2 70P2-16	1 70P2-16	2 701.4.4	2 70P2-15	
					1 70P2-17				
BEARING SEAL							2 91P2-15		
SHIM	5 80P1-4	7 80P1-21	7 80P1-21	7 80P1-21	5 80P1-21	5 80P1-21	5 80P1-4	5 80P1-25	5 80P1-12
	5 80P2-1	5 80P2-17	5 80P2-17	5 80P2-17	5 80P2-17	5 80P2-17	5 80P2-1	5 80P2-21	5 80P2-10
CAP SCREW				12 1/4-28X5/8	2 5/16-18X5/8	2 5/16-18X5/8			
NUT	2 50P19-1	2 50P19-2	2 50P19-2	2 50P19-2	2 50P19-2	2 50P19-2	2 50P19-2	4 50P19-1	2 50P19-1
LOCK WASHER				12 1/4	2 5/16 FLAT	2 5/16 FLAT			
FELT WASHER									
EXPANSION PLUG									
RELIEF FITTING									
COTTER PIN									
LOCK RING									
CASTLE NUT									

KIT REF.	70.120.09	70.120.18	70.120.95	70.120.99	70.121.05	70.122.05	70.122.95	70.123.05	70.125.23
PART REF.	QTY PART NO.	QTY PART NO.	QTY PART NO.	QTY PART NO.	QTY PART NO.	QTY PART NO.	QTY PART NO.	QTY PART NO.	QTY PART NO.
KING PIN	2 105.38.2	2 105.33.3	2 105.24.10	2 105.38.2	2 105.24.10	2 105.35.3	2 105.35.3	2 105.55.2	2 105.18.2
BUSHING	4 202.21.11	4 202.20.1	4 202.16.8	4 201.21.13	4 202.16.9	4 202.19.10	4 202.19.9	4 202.19.10	4 202.18.1
STEEL LINER									
TAPER LOCK PINS	2 60M2-19	2 60M1-1	2 60M2-15	2 60M2-19	2 60M2-15	2 60M1-9	2 60M1-9	2 60M1-16	2 60M2-8
	2 60M2-20	2 60M1-8		2 60M2-20				2 60M1-17	
END PLATE / PLUG		4 401.128.1	4 401.129.1		4 401.129.1	4 45P6-1	4 45P6-1	4 45P6-1	4 401.20.1
O-RING GASKET	4 92P1-20	4 92P1-4	4 41P5-2	4 92P1-20	4 41P5-2	4 93P1-12	4 93P1-12	4 93P1-12	
BUSHING SEAL	4 91P1-32	4 91P1-29	4 91P1-25	4 91P1-32	4 91P1-25	4 91P1-29	4 91P1-29	4 91P1-29	4 91P1-44
BEARING	2 701.4.21	2 701.4.27	2 701.4.19	2 701.4.21	2 70P2-13	2 701.4.2	2 701.4.2	2 701.4.28	2 701.4.25
BEARING SEAL									
SHIM	6 80P1-23	5 80P1-19	5 80P1-14	6 80P1-23	5 80P1-14	3 80P1-2	3 80P1-2	3 80P1-2	5 80P1-2
	6 80P2-19	3 80P2-15	5 80P2-11	6 80P2-19	5 80P2-11	5 80P2-5	5 80P2-5	5 80P2-5	5 80P2-5
	4 80P3-30	4 80P3-33		4 80P3-30		4 80P3-24	4 80P3-24	2 80P3-24	
CAP SCREW	12 5/16-18X1	12 5/16-18X1	12 5/16-18X1	12 5/16-18X1	12 5/16-18X1				12 1/4-20 X 3/4
NUT	4 50P19-2	4 50P19-1	2 50P19-3	4 50P19-2	2 50P19-3	2 50P19-1	2 50P19-1	4 50P19-2	2 50P19-1
LOCK WASHER	12 5/16	12 5/16	12 5/16	12 5/16	12 5/16				12 1/4
FELT WASHER									
EXPANSION PLUG									
RELIEF FITTING									4 90P1-1
COTTER PIN									
LOCK RING									
CASTLE NUT									

KIT REF.	70.075.06	70.076.06	70.080.18	70.098.09	70.101.09	70.102.09	70.103.19	70.119.09	70.120.05
PART REF.	QTY PART NO.	QTY PART NO.	QTY PART NO.	QTY PART NO.	QTY PART NO.	QTY PART NO.	QTY PART NO.	QTY PART NO.	QTY PART NO.
KING PIN	2 105.25.1	2 105.25.1	2 105.52.2	2 105.12.3	2 105.13.1	2 105.37.1	2 105.56.1	2 105.16.2	2 105.24.10
BUSHING	4 202.14.6	4 202.14.6	4 202.15.7	4 202.12.3	4 202.13.1	4 202.13.1	4 202.13.1	4 202.17.1	4 202.16.9
STEEL LINER									
TAPER LOCK PINS	2 60M1-1	2 60M1-1	2 60M1-14	2 60M7-1	2 60M7-1	2 60M4-10	4 60M2-20	4 602.4.1	2 60M2-15
	2 60M1-2	2 60M1-2	2 60M1-7			2 60M4-11			
						2 60M7-8			
END PLATE / PLUG		4 45P2-5							4 401.129.1
O-RING GASKET	2 41P7-1			4 41P3-3	4 92P1-16	4 92P1-16	4 92P1-28	4 92P1-15	4 41P5-2
BUSHING SEAL	4 91P1-16	4 91P1-16	4 91P1-41		4 91P1-14	4 91P1-14	4 91P1-14		4 91P1-25
BEARING	2 701.4.5	2 701.4.5	2 701.4.5	2 701.4.4	2 701.4.35	2 701.4.35	2 701.4.35	2 701.4.1	2 701.4.19
BEARING SEAL			2 91P2-15						
SHIM	5 80P1-5	5 80P1-5	5 80P1-25	5 80P1-4	4 80P1-22	5 80P1-22	5 80P1-22	7 80P1-1	5 80P1-14
	5 80P2-2	5 80P2-2	5 80P2-21	5 80P2-1	4 80P2-18	5 80P2-18	5 80P2-18		5 80P2-11
CAP SCREW									12 5/16-18X1
NUT	4 50P19-1	4 50P19-1	4 50P19-1	2 50P19-2	2 50P19-2	2 50P19-2	4 50P19-2		2 50P19-3
LOCK WASHER									12 5/16
FELT WASHER									
EXPANSION PLUG	2 45P1-11								
RELIEF FITTING									
COTTER PIN									
LOCK RING	2 100P1-3								
CASTLE NUT									

KIT REF.	70.126.23	70.127.23	70.130.23	70.139.09	70.140.09	70.141.19	70.146.05	70.147.05	70.160.19
PART REF.	QTY PART NO.	QTY PART NO.	QTY PART NO.	QTY PART NO.	QTY PART NO.	QTY PART NO.	QTY PART NO.	QTY PART NO.	QTY PART NO.
KING PIN	2 105.18.2	2 105.18.2	2 105.21.3	2 105.24.1	2 105.16.13	2 105.38.6	2 105.35.2	2 105.55.1	2 105.38.4
BUSHING	4 202.18.1	4 202.18.1	4 202.20.1	4 202.17.1	4 202.17.1	4 202.21.10	4 202.18.8	4 202.18.8	4 202.21.10
STEEL LINER									
TAPER LOCK PINS	2 60M2-8	2 60M2-8	2 60M1-1	2 60M2-11	4 602.4.1	4 60M2-19	2 60M1-9	2 60M1-16	2 60M1-12
	2 60M2-8	2 60M2-8				2 60M1-17		2 60M1-17	2 60M1-13
END PLATE / PLUG	4 401.20.1	4 45P2-3	4 45P2-3					4 45P6-1	
O-RING GASKET				4 92P1-15	4 92P1-15	4 92P1-20	4 93P1-12	4 93P1-12	4 92P1-21
						4 92P1-21			
BUSHING SEAL	4 91P1-44	4 91P1-44	4 91P1-29	4 91P3-1	4 91P3-1	4 91P1-34	4 91P1-36	4 91P1-36	4 91P1-34
BEARING	2 701.4.17	2 701.4.20	2 701.4.27	2 701.4.1	2 701.4.1	2 701.4.37	2 701.4.24	2 701.4.25	2 701.4.37
BEARING SEAL		2 91P2-11		2 91P2-2	2 91P2-2				
SHIM	5 80P1-2	5 80P1-2	4 80P1-19	7 80P1-1	7 80P1-1	3 80P1-23	3 80P1-24	3 80P1-24	3 80P1-23
	5 80P2-5	5 80P2-5	4 80P2-15	2 80P3-13	2 80P3-13	3 80P2-19	5 80P2-20	5 80P2-20	3 80P2-19
			4 80P3-33			2 80P3-30	2 80P3-31	2 80P3-31	2 80P3-30
CAP SCREW	12 1/4-20 X 3/4								
NUT	2 50P19-1		2 50P19-1	2 50P19-3		4 50P19-2	2 50P19-3	4 50P19-2	4 50P19-2
LOCK WASHER	12 1/4								
FELT WASHER									
EXPANSION PLUG									
RELIEF FITTING	4 90P1-1								
COTTER PIN									
LOCK RING									
CASTLE NUT									

PLUSKIT COMPONENTS

KIT REF.	70.180.05	70.180.18	70.181.18	70.230.07	70.309.09	70.310.09	70.533.13	70.616.13	70.700.20
PART REF.	QTY PART NO.	QTY PART NO.	QTY PART NO.	QTY PART NO.	QTY PART NO.	QTY PART NO.	QTY PART NO.	QTY PART NO.	QTY PART NO.
KING PIN	2 105.35.1	2 105.22.5	2 105.22.2	2 105.35.6	2 105.24.2	2 105.16.12	2 95.15.3	2 95.18.2	1 105.60.1 1 105.61.1
BUSHING	4 202.18.4	4 202.21.2	4 202.21.2	2 202.27.2 2 202.27.3	4 202.17.1	4 202.17.1	2 202.16.3	2 201.23.1	4 202.27.1
STEEL LINER									
TAPER LOCK PINS	2 60M2-18	2 60M1-1 2 60M1-8	2 60M1-4 2 60M1-8		2 60M2-11	4 602.4.1			4 60M2-27
END PLATE / PLUG			4 401.128.2	4 401.146.1			2 45P10-2	2 45P10-1	4 401.145.1
O-RING GASKET	4 41P11-1	4 41P4-2	4 92P1-9	4 92P1-41 2 92P1-42	4 92P1-15	4 92P1-15	2 92P1-30	2 92P1-30	4 92P1-32 4 92P1-39
BUSHING SEAL	4 91P1-36	4 91P1-15	4 91P1-15		4 91P3-1	4 91P3-1	2 91P1-11 2 91P1-12	2 91P1-21 2 91P1-22	
BEARING	2 701.4.24	2 701.4.37	2 701.4.37	2 70P7-1	2 701.4.1	2 701.4.1	2 70P2-1 2 70P3-2	2 70P2-8 2 70P3-3	2 70P6-1
BEARING SEAL					2 91P2-2	2 91P2-2			
SHIM	3 80P1-9 3 80P2-7 2 80P3-29 2 80P3-34	3 80P1-9 3 80P2-7 2 80P3-29 2 80P3-34	3 80P1-9 3 80P2-7 2 80P3-29 2 80P3-34	7 80P1-1	11 80P1-1 12 80P3-13				4 80P1-30 10 80P2-27
CAP SCREW	16 5/16-18X1	12 5/16-18 X 1	12 5/16-18 X 1	12 5/16-24 X 3/4					2 3/8-16 X 1-1/4
NUT	2 50P19-3	4 50P19-1	4 50P19-1	2 50P19-3					4 50P19-1
LOCK WASHER	16 5/16	12 5/16	12 5/16	12 5/16					
FELT WASHER									
EXPANSION PLUG						2 50P1-1	2 50P1-1		
RELIEF FITTING									
COTTER PIN									
LOCK RING									
CASTLE NUT									

KIT REF.	77.931.18	78.931.06	78.931.12	78.946.18
PART REF.	QTY PART NO.	QTY PART NO.	QTY PART NO.	QTY PART NO.
KING PIN	2 105.21.3	2 105.22.2	2 105.22.2	2 105.21.14
BUSHING	4 202.20.1	4 202.21.2	4 202.21.2	2 202.19.10 2 202.19.11
STEEL LINER				
TAPER LOCK PINS	2 60M1-1 2 60M1-2 2 60M1-8	2 60M1-3 2 60M1-4	2 60M1-3 2 60M1-4	2 60M1-3 2 60M1-4 2 60M1-8
END PLATE / PLUG				4 45P7-1
O-RING GASKET	4 41P7-1	4 41P4-2	4 41P4-2	
BUSHING SEAL	4 91P1-29	2 91P1-15	2 91P1-15	4 91P1-29
BEARING	2 701.4.30	2 701.4.11	2 701.4.37	2 701.4.27
BEARING SEAL				
SHIM	5 80P1-2 8 80P2-5	5 80P1-9 9 80P2-7 2 80P3-29 2 80P3-34	5 80P1-9 9 80P2-7 2 80P3-29 2 80P3-34	5 80P1-2 5 80P2-5
CAP SCREW				
NUT	4 50P19-1	4 50P19-1	4 50P19-1	4 50P19-1
LOCK WASHER				
FELT WASHER				
EXPANSION PLUG				
RELIEF FITTING				
COTTER PIN				
LOCK RING				
CASTLE NUT				

KIT REF.	70.901.12	70.921.12	70.931.12	70.941.06	70.941.18	70.942.06	70.961.12	70.981.18	74.901.18
PART REF.	QTY PART NO.	QTY PART NO.	QTY PART NO.	QTY PART NO.	QTY PART NO.	QTY PART NO.	QTY PART NO.	QTY PART NO.	QTY PART NO.
KING PIN	2 10M21-1	2 105.21.2	2 105.21.3	2 105.33.2	2 105.52.1	2 105.33.2	2 105.21.3	2 105.21.12	2 105.14.1
BUSHING	4 202.19.5	4 202.20.1	4 202.20.1	4 202.15.7	4 202.15.7	4 202.19.5	4 202.20.1	4 202.19.10	4 202.14.6
STEEL LINER									
TAPER LOCK PINS	2 60M7-3 2 60M7-4	2 60M7-3 2 60M7-4	2 60M1-1 2 60M1-2	2 60M1-1 2 60M1-2	2 60M1-7 2 60M1-14	2 60M1-1 2 60M1-2	2 60M1-7 2 60M1-8	2 60M1-7 2 60M1-8	4 602.4.1
END PLATE / PLUG					4 401.139.1	4 45P2-3		4 45P2-3	
O-RING GASKET	2 41P7-1	4 41P7-1	2 41P7-1	4 41P7-1	4 92P1-26		4 41P7-1		2 41P7-1
BUSHING SEAL	4 91P1-29	4 91P1-6	4 91P1-29	4 91P1-29	4 91P1-41	4 91P1-29	4 91P1-29	4 91P1-29	
BEARING	2 701.4.2	2 701.4.27	2 701.4.27	2 701.4.2	2 701.4.5	2 701.4.2	2 701.4.27	2 701.4.27	2 701.4.5
BEARING SEAL					2 91P2-15				
SHIM	5 80P1-2 8 80P2-5	5 80P1-2 8 80P2-5	5 80P1-2 8 80P2-5	5 80P1-2 8 80P2-5	5 80P2-21	9 80P1-2	5 80P1-2 8 80P2-5	5 80P1-19 5 80P2-15	5 80P1-5 5 80P2-2
CAP SCREW					12 5/16-18X1				
NUT	4 50P19-2	4 50P19-2	4 50P19-1	4 50P19-1	4 50P19-1	4 50P19-1	4 50P19-1	4 50P19-1	
LOCK WASHER					12 5/16				
FELT WASHER									
EXPANSION PLUG	2 45P1-9								2 45P1-11
RELIEF FITTING	2 90P1-1								
COTTER PIN									
LOCK RING	2 100P1-1								2 100P1-3
CASTLE NUT									

TIE ROD END INTERCHANGE TO QWIKTIE ASSEMBLY

COMPETITOR #	ASSEMBLY	LEFT*	RIGHT*
AUTOCAR			
872469	QT967SS		QTE967R
872470	QT967SS	QTE967L	
85108888	QT108SB	QTE108L	
85108889	QT108SB		QTE108R
370240004	QT967SS	QTE967L	
370240005	QT967SS		QTE967R
370245001	QT108SB	QTE108L	
370245002	QT108SB		QTE108R
887783A	QT108SB	QTE108L	
887784A	QT108SB		QTE108R
A8010185	QT108SB		QTE108R
A8010186	QT108SB	QTE108L	
A8015593	QT108SB	QTE108L	
A8015594	QT108SB		QTE108R
L24SV5042A12	QT967SS		QTE967R
L24SV5043A12	QT967SS	QTE967L	
AUTOMANN			
462.ES187L	QT967SS	QTE967L	
462.ES187R	QT967SS		QTE967R
462.ES2090L	QT108SB	QTE108L	
462.ES2090S	QT108SB	QTE108L	
462.ES2091R	QT108SB		QTE108R
462.ES2091RS	QT108SB		QTE108R
462.ES2118L	QT967SS		QTE967R
462.ES2203R	QT967SS		QTE967R
462.ES2614L	QT967SS	QTE967L	
462.ES2614R	QT967SS		QTE967R
462.ES3030R	QT108SB		QTE108R
462.ES3031L	QT108SB	QTE108L	
462.ES3033L	QT108SB	QTE108L	
462.ES3034R	QT108SB		QTE108R
462.ES3176R	QT967SS		QTE967R
462.ES3177L	QT967SS	QTE967L	
462.ES3219L	QT967SS	QTE967L	
462.ES3220R	QT967SS		QTE967R
462.ES3297R	QT967SS		QTE967R
462.ES3298L	QT967SS	QTE967L	
462.ES3312R	QT967SS		QTE967R
462.ES3442R	QT967SS		QTE967R
462.ES3443L	QT967SS	QTE967L	
462.ES346L	QT108SB		QTE108R
462.ES346R	QT108SB	QTE108L	
462.ES411L	QT967SS	QTE967L	
462.ES411R	QT967SS		QTE967R
462.ES423L	QT967SS	QTE967L	
462.ES423R	QT967SS		QTE967R
462.ES431L	QT108SB	QTE108L	
462.ES431LS	QT108SB	QTE108L	
462.ES431R	QT108SB	QTE108L	
462.ES431RS	QT108SB	QTE108L	
462.ES4601L	QT108SB	QTE108L	
462.ES4601R	QT108SB		QTE108R
462.ES9001L	QT967SS	QTE967L	
462.ES9001R	QT967SS		QTE967R

COMPETITOR #	ASSEMBLY	LEFT*	RIGHT*
AUTOMANN CONT.			
462.ES9328L	QT108SB	QTE108L	
462.ES9329R	QT108SB		QTE108R
462.ES9678L	QT967SS	QTE967L	
462.ES9679R	QT967SS		QTE967R
463.DS1261	QT967SS	QTE967L	QTE967R
463.DS1367A	QT967SS	QTE967L	QTE967R
463.DS1368A	QT967SS	QTE967L	QTE967R
463.DS1379A	QT967SS	QTE967L	QTE967R
463.DS1380A	QT967SS	QTE967L	QTE967R
463.DS3138	QT108SB	QTE108L	QTE108R
463.DS3156	QT967SS	QTE967L	QTE967R
463.DS3158	QT967SS	QTE967L	QTE967R
463.DS4301	QT967SS	QTE967L	QTE967R
463.DS4602	QT967SS	QTE967L	QTE967R
463.DS5003	QT967SS	QTE967L	QTE967R
463.DS5090	QT967SS	QTE967L	QTE967R
463.DS55710	QT967SS	QTE967L	QTE967R
463.DS7526	QT967SS	QTE967L	QTE967R
463.DS9800	QT967SS	QTE967L	QTE967R
463.DS9801	QT108SB	QTE108L	QTE108R
463.DS9802	QT108SB	QTE108L	QTE108R
463.DS9803	QT967SS	QTE967L	QTE967R
463.DS9804	QT967SS	QTE967L	QTE967R
463.DS9807	QT108SB	QTE108L	QTE108R
463.DS9808	QT967SS	QTE967L	QTE967R
463.DS9811	QT108SB	QTE108L	QTE108R
463.DS9812	QT108SB	QTE108L	QTE108R
463.DS9813	QT967SS	QTE967L	QTE967R
463.DS9816	QT108SB	QTE108L	QTE108R
463.DS9817	QT108SB	QTE108L	QTE108R
463.DS9818	QT108SB	QTE108L	QTE108R
463.DS9819	QT108SB	QTE108L	QTE108R
463.DS9820	QT967SS	QTE967L	QTE967R
463.DS9822	QT967SS	QTE967L	QTE967R
463.DS9823	QT967SS	QTE967L	QTE967R
463.DS9824	QT108SB	QTE108L	QTE108R
463.DS9826	QT108SB	QTE108L	QTE108R
463.DS9827	QT108SB	QTE108L	QTE108R
463.DS9828	QT108SB	QTE108L	QTE108R
463.DS9829	QT108SB	QTE108L	QTE108R
463.DS9830	QT967SS	QTE967L	QTE967R
463.DS9831	QT108SB	QTE108L	QTE108R
463.DS9832	QT108SB	QTE108L	QTE108R
463.DS9833	QT967SS	QTE967L	QTE967R
463.DS9834	QT108SB	QTE108L	QTE108R
463.DS9835	QT967SS	QTE967L	QTE967R
463.DS9836	QT108SB	QTE108L	QTE108R
463.DS9837	QT108SB	QTE108L	QTE108R
463.DS9838	QT108SB	QTE108L	QTE108R
463.DS9839	QT967SS	QTE967L	QTE967R
463.DS9840	QT967SS	QTE967L	QTE967R
463.DS9841	QT967SS	QTE967L	QTE967R
463.DS9842	QT108SB	QTE108L	QTE108R
463.DS9843	QT108SB	QTE108L	QTE108R

COMPETITOR #	ASSEMBLY	LEFT*	RIGHT*
AUTOMANN CONT.			
463.DS9845	QT967SS	QTE967L	QTE967R
463.DS9846	QT967SS	QTE967L	QTE967R
463.DS9847	QT967SS	QTE967L	QTE967R
463.DS9848	QT967SS	QTE967L	QTE967R
463.DS9850	QT108SB	QTE108L	QTE108R
463.DS9853	QT967SS	QTE967L	QTE967R
463.DS9856	QT967SS	QTE967L	QTE967R
463.DS9857	QT108SB	QTE108L	QTE108R
463.DS9858	QT967SS	QTE967L	QTE967R
463.DS9859	QT108SB	QTE108L	QTE108R
463.DS9861	QT108SB	QTE108L	QTE108R
463.DS9862	QT967SS	QTE967L	QTE967R
463.DS9864	QT967SS	QTE967L	QTE967R
463.DS9865	QT108SB	QTE108L	QTE108R
463.DS9868	QT108SB	QTE108L	QTE108R
463.DS9869	QT108SB	QTE108L	QTE108R
463.DS9870	QT967SS	QTE967L	QTE967R
463.DS9871	QT108SB	QTE108L	QTE108R
463.DS9872	QT108SB	QTE108L	QTE108R
463.DS9873	QT108SB	QTE108L	QTE108R
463.DS9877	QT967SS	QTE967L	QTE967R
463.DS9878	QT967SS	QTE967L	QTE967R
463.DS9879	QT967SS	QTE967L	QTE967R
463.DS9880	QT967SS	QTE967L	QTE967R
463.DS9881	QT967SS	QTE967L	QTE967R
463.DS9882	QT108SB	QTE108L	QTE108R
463.DS9883	QT108SB	QTE108L	QTE108R
463.DS9884	QT108SB	QTE108L	QTE108R
463.DS9885	QT108SB	QTE108L	QTE108R
463.DS9886	QT967SS	QTE967L	QTE967R
463.DS9887	QT967SS	QTE967L	QTE967R
463.DS9889	QT108SB	QTE108L	QTE108R
463.DS9890	QT108SB	QTE108L	QTE108R
463.DS9891	QT108SB	QTE108L	QTE108R
463.DS9893	QT967SS	QTE967L	QTE967R
463.DS9896	QT108SB	QTE108L	QTE108R
463.DS9897	QT108SB	QTE108L	QTE108R
463.DS9898	QT967SS	QTE967L	QTE967R
463.DS9899	QT967SS	QTE967L	QTE967R
463.DS9901	QT967SS	QTE967L	QTE967R
463.DS9902	QT108SB	QTE108L	QTE108R
463.DS9903	QT967SS	QTE967L	QTE967R
BATCO			
21187L	QT967SS	QTE967L	
21187R	QT967SS		QTE967R
212041L	QT108SB	QTE108L	
212091R	QT108SB		QTE108R
212115R	QT108SB	QTE108L	QTE108R
212116L	QT108SB	QTE108L	
212118L	QT967SS		QTE967R
212202R	QT108SB		QTE108R
212204R	QT108SB		QTE108R
212207R	QT108SB		QTE108R
212208R	QT108SB		QTE108R

*Only compatible with STEMCO Cross Tube QTT5773

COMPETITOR #	ASSEMBLY	LEFT*	RIGHT*
BATCO CONT.			
212209R	QT108SB		QTE108R
21220R	QT108SB	QTE108L	
212614R	QT967SS		QTE967R
213030R	QT108SB		QTE108R
213034R	QT108SB		QTE108R
21346L	QT108SB	QTE108L	
21376L	QT108SB	QTE108L	
21411L	QT967SS	QTE967L	
21411R	QT967SS		QTE967R
21423L	QT967SS	QTE967L	
21423R	QT967SS		QTE967R
21431L	QT108SB	QTE108L	
21431R	QT108SB	QTE108L	
BLUE BIRD			
63810	QT967SS	QTE967L	
663811	QT108SB		QTE967R
2597151	QT967SS	QTE967L	
2597250	QT108SB		QTE967R
4278487	QT967SS	QTE967L	
4278503	QT108SB		QTE967R
CHEVROLET / GMC			
685504	QT108SB		QTE108R
685505	QT108SB	QTE108L	
798203	QT108SB		QTE108R
798204	QT108SB	QTE108L	
2452860	QT108SB		QTE108R
2452861	QT108SB	QTE108L	
12541319	QT108SB	QTE108L	
12541320	QT108SB		QTE108R
15579760	QT108SB		QTE108R
15617769	QT967SS	QTE967L	QTE967R
88936085	QT108SB	QTE108L	
88936086	QT108SB		QTE108R
CHRYSLER			
1643277	QT967SS		QTE967R
1643278	QT967SS	QTE967L	
2585607	QT108SB	QTE108L	
2585608	QT108SB		QTE108R
3634206	QT108SB		QTE108R
3634207	QT108SB	QTE108L	
3744496	QT967SS		QTE967R
3744497	QT967SS	QTE967L	
L24SV5042A12	QT967SS		QTE967R
L24SV5043A12	QT967SS	QTE967L	
DANA			
2692705	QT967SS		QTE967R
120TR109	QT967SS	QTE967L	
120TR110	QT967SS		QTE967R
120TR111	QT967SS	QTE967L	
120TR112	QT967SS		QTE967R
140TR111	QT967SS	QTE967L	
140TR112	QT967SS		QTE967R
220TR115	QT108SB	QTE108L	

COMPETITOR #	ASSEMBLY	LEFT*	RIGHT*
DANA CONT.			
220TR116	QT108SB		QTE108R
220TR118	QT108SB	QTE108L	
220TR119	QT108SB		QTE108R
DAYTON			
310-121	QT967SS	QTE967L	
310-122	QT967SS		QTE967R
310-169	QT108SB	QTE108L	
310-170	QT108SB		QTE108R
310-215	QT967SS	QTE967L	
310-216	QT967SS		QTE967R
310-222	QT967SS	QTE967L	
310-223			

TIE ROD END INTERCHANGE TO QWIKTIE ASSEMBLY

COMPETITOR #	ASSEMBLY	LEFT*	RIGHT*
ELGIN CONT.			
ES3297R	QT967SS		QTE967R
ES3298L	QT967SS	QTE967L	
ES3312R	QT967SS		QTE967R
ES3442R	QT967SS		QTE967R
ES3443L	QT967SS	QTE967L	
ES346L	QT108SB		QTE108R
ES346R	QT108SB	QTE108L	
ES3476	QT967SS		QTE967R
ES3477	QT967SS	QTE967L	
ES411L	QT967SS	QTE967L	
ES411R	QT967SS		QTE967R
ES423L	QT967SS	QTE967L	
ES423R	QT967SS		QTE967R
ES431L	QT108SB		QTE108R
ES431LA	QT108SB		QTE108R
ES431R	QT108SB	QTE108L	
ES431RA	QT108SB	QTE108L	
EUCLID			
E-10137	QT967SS		QTE967R
E-10138	QT967SS	QTE967L	
E-11023	QT967SS		QTE967R
E-11788	QT967SS		QTE967R
E-11789	QT967SS	QTE967L	
E-11981	QT967SS		QTE967R
E-14326	QT967SS	QTE967L	
E-4610	QT967SS	QTE967L	
E-4611	QT967SS		QTE967R
E-4614	QT967SS	QTE967L	
E-4615	QT967SS		QTE967R
E-4616	QT108SB	QTE108L	
E-4617	QT108SB		QTE108R
E-4617TU	QT108SB		QTE108R
E-4618	QT108SB		QTE108R
E-4619	QT108SB	QTE108L	
E-4628	QT108SB	QTE108L	
E-4629	QT108SB		QTE108R
E-4630	QT967SS	QTE967L	
E-4631	QT967SS		QTE967R
E-4640	QT967SS		QTE967R
E-4642	QT108SB		QTE108R
E-5393	QT108SB		QTE108R
E-5396	QT108SB	QTE108L	
E-5397	QT108SB		QTE108R
E-5470	QT967SS		QTE967R
E-6849	QT967SS		QTE967R
E-6856	QT108SB		QTE108R
E-6857	QT108SB	QTE108L	
E-8757	QT967SS	QTE967L	
E-8758	QT967SS		QTE967R
E-9661	QT967SS	QTE967L	QTE967R
E-9877	QT108SB		QTE108R
E-9878	QT108SB	QTE108L	
E-9879	QT108SB		QTE108R
E-9880	QT108SB	QTE108L	

COMPETITOR #	ASSEMBLY	LEFT*	RIGHT*
EUCLID CONT.			
E-9949	QT967SS	QTE967L	
E-9950	QT967SS		QTE967R
E-9951	QT967SS	QTE967L	
E-9952	QT967SS		QTE967R
E-9956	QT967SS		QTE967R
E-9962	QT967SS	QTE967L	
E-9963	QT967SS		QTE967R
E-9964	QT967SS	QTE967L	QTE967R
FLAGG			
ES187L	QT967SS	QTE967L	
ES187R	QT967SS		QTE967R
ES2090L	QT108SB	QTE108L	
ES2091R	QT108SB		QTE108R
ES2114R	QT108SB		QTE108R
ES2116L	QT108SB	QTE108L	
ES2118L	QT967SS		QTE967R
ES2202R	QT108SB		QTE108R
ES2203R	QT967SS		QTE967R
ES2208R	QT108SB		QTE108R
ES2614R	QT967SS		QTE967R
ES3030R	QT108SB		QTE108R
ES3031L	QT108SB	QTE108L	
ES3176R	QT967SS		QTE967R
ES3177L	QT967SS	QTE967L	
ES3178R	QT967SS		QTE967R
ES3216R	QT967SS		QTE967R
ES3217L	QT967SS	QTE967L	
ES3218R	QT967SS		QTE967R
ES3219L	QT967SS	QTE967L	
ES3297R	QT967SS		QTE967R
ES3298L	QT967SS	QTE967L	
ES3312R	QT967SS		QTE967R
ES3442R	QT967SS		QTE967R
ES3443L	QT967SS	QTE967L	
ES3476	QT967SS		QTE967R
ES3477	QT967SS	QTE967L	
ES376L	QT108SB	QTE108L	
ES376R	QT108SB		QTE108R
ES411L	QT967SS	QTE967L	
ES411R	QT967SS		QTE967R
ES423L	QT967SS	QTE967L	
ES423R	QT967SS		QTE967R
ES431LA	QT108SB		QTE108R
ES431LS	QT108SB		QTE108R
ES431R	QT108SB	QTE108L	
ES431RA	QT108SB	QTE108L	
ES431RS	QT108SB	QTE108L	
ES9001R	QT967SS	QTE967L	
ES9009	QT967SS	QTE967L	
ES9010	QT967SS		QTE967R
KW1	QT108SB		QTE108R

COMPETITOR #	ASSEMBLY	LEFT*	RIGHT*
FLEETRITE			
FTR2091R	QT108SB		QTE108R
FTR2203R	QT967SS		QTE967R
FTR2208R	QT108SB		QTE108R
FTR2614R	QT967SS		QTE967R
FTR3030R	QT108SB		QTE108R
FTR3034R	QT108SB		QTE108R
FTR346L	QT108SB		QTE108R
FTR346R	QT108SB	QTE108L	
FTR411L	QT967SS	QTE967L	
FTR411R	QT967SS		QTE967R
FTR423L	QT967SS	QTE967L	
FTR423R	QT967SS		QTE967R
FTR431L	QT108SB		QTE108R
FTR431R	QT108SB	QTE108L	
FORD			
4C403280BA	QT967SS	QTE967L	
4C403280CA	QT967SS	QTE967L	QTE967R
4C403A130JA	QT967SS		QTE967R
4C403A130KA	QT967SS	QTE967L	
4C403A130LA	QT967SS		QTE967R
4C403A130MA	QT967SS	QTE967L	
4C403A130NA	QT967SS		QTE967R
4C403A130PA	QT967SS	QTE967L	
4C4Z3280CA	QT967SS	QTE967L	QTE967R
4C4Z3280AA	QT967SS		QTE967R
4C4Z3280BA	QT967SS	QTE967L	
4C4Z3280CB	QT967SS	QTE967L	QTE967R
4C4Z3A130J	QT967SS		QTE967R
4C4Z3A130K	QT967SS	QTE967L	
4C4Z3A130LA	QT967SS		QTE967R
4C4Z3A130MA	QT967SS	QTE967L	
4C4Z3A130NA	QT967SS		QTE967R
4C4Z3A130PA	QT967SS	QTE967L	
B5T23A130A	QT967SS		QTE967R
B5T23A131A	QT967SS	QTE967L	
B8T23A130B	QT108SB		QTE108R
B8T23A131B	QT108SB		QTE108R
C1T23A130C	QT967SS		QTE967R
C1T23A131C	QT967SS	QTE967L	
C8T23A130A	QT967SS		QTE967R
DOHZ3A130A	QT967SS		QTE967R
DOHZ3A130B	QT108SB		QTE108R
DOHZ3A130C	QT108SB		QTE108R
DOHZ3A131A	QT967SS	QTE967L	
DOHZ3A131B	QT108SB	QTE108L	
DOHZ3A131C	QT108SB	QTE108R	
E3HZ3A130A	QT967SS		QTE967R
E3HZ3A131A	QT967SS	QTE967L	
E4HZ3280B	QT967SS	QTE967L	QTE967R
E4HZ3A130A	QT967SS		QTE967R
E4HZ3A130B	QT967SS		QTE967R
E4HZ3A131A	QT967SS	QTE967L	
F1HZ3280C	QT967SS	QTE967L	QTE967R
F1HZ3A130A	QT967SS		QTE967R

*Only compatible with STEMCO Cross Tube QTT5773

COMPETITOR #	ASSEMBLY	LEFT*	RIGHT*
FORD CONT.			
F1HZ3A130B	QT967SS		QTE967R
F1HZ3A131A	QT967SS	QTE967L	
F3HZ3280E	QT967SS	QTE967L	QTE967R
F3HZ3A130B	QT967SS		QTE967R
F3HZ3A131A	QT967SS	QTE967L	
F4HZ3280A	QT967SS	QTE967L	QTE967R
F4HZ3280B	QT967SS	QTE967L	QTE967R
F4HZ3280C	QT967SS	QTE967L	QTE967R
F5HT3280DA	QT967SS	QTE967L	QTE967R
F5HZ3280A	QT967SS	QTE967L	QTE967R
F5HZ3A130AA	QT967SS		QTE967R
F5HZ3A131AA	QT967SS	QTE967L	
F6HZ3A130AA	QT967SS		QTE967R
F6HZ3A131AA	QT967SS	QTE967L	
FREIGHTLINER			
817018	QT967SS	QTE967L	
817019	QT967SS		QTE967R
1009009	QT967SS	QTE967L	
1009010	QT967SS		QTE967R
6070910	QT108SB	QTE108L	
6073380010	QT108SB	QTE108L	
6073381010	QT967SS	QTE967L	
6073381310	QT108SB		QTE108R
6073381410	QT108SB		QTE108R
6073382410	QT967SS		QTE967R
6803302703	QT967SS	QTE967L	QTE967R
6803302903	QT967SS	QTE967L	QTE967R
6803303603	QT108SB	QTE108L	QTE108R
6803303803	QT967SS	QTE967L	QTE967R
6803303903	QT108SB	QTE108L	QTE108R
6803304403	QT967SS	QTE967L	QTE967R
6803307303	QT108SB	QTE108L	QTE108R
6803308003	QT967SS	QTE967L	QTE967R
6803308303	QT967SS	QTE967L	QTE967R
681-460-15-05	QT108SB		QTE108R
A3144C237	QT108SB	QTE108L	
A3144C549	QT108SB	QTE108L	
A3144D238	QT108SB		QTE108R
A3144D524	QT967SS		QTE967R
A3144D550	QT108SB		QTE108R
A3144E525	QT967SS	QTE967L	
A3144F448	QT108SB		QTE108R
A3144G449	QT108SB	QTE108L	
A3144J296	QT108SB	QTE108L	
A3144J296	QT108SB	QTE108L	
A3144K297	QT108SB	QTE108L	
A3144Q225	QT967SS	QTE967L	
A3144R226	QT967SS		QTE967R
A6073381010	QT967SS	QTE967L	
A6073382410	QT967SS		QTE967R
L24SV5001A13	QT967SS		QTE967R
L24SV5001A14	QT967SS		QTE967R
L24SV5042A12	QT967SS		QTE967R
L24SV5042B12	QT967SS		QTE967R

COMPETITOR #	ASSEMBLY	LEFT*	RIGHT*
FREIGHTLINER CONT.			
L24SV5043A12	QT967SS	QTE967L	
L24SV5043A14	QT967SS	QTE967L	
L24SV5700A12	QT967SS		QTE967R
L28SV5000A14	QT108SB	QTE108L	
L28SV5000A18	QT108SB	QTE108L	
L28SV5000A18	QT108SB	QTE108L	
L28SV5000A30	QT108SB		QTE108R
L28SV5000H29	QT108SB	QTE108L	
L28SV5000H35	QT108SB	QTE108L	
L28SV5001A18	QT108SB		QTE108R
L28SV5003A14	QT108SB	QTE108L	
L28SV5003B18	QT108SB		QTE108R
L28SV5004D1	QT108SB		QTE108R
L28SV5200A12	QT108SB		QTE108R
L28SV5200D12	QT108SB	QTE108L	
L28SV5201A12	QT108SB	QTE108L	
L28SV5201D12	QT108SB	QTE108L	
L28SV5207B16	QT108SB		QTE108R
MBA6073381010	QT967SS	QTE967L	
MBA6073382410	QT967SS		QTE967R
HENDRICKSON			
2890	QT967SS	QTE967L	QTE967R
29141	QT967SS	QTE967L	
29142	QT108SB		QTE967R
60239003	QT967SS	QTE967L	QTE967R
60961025	QT967SS	QTE967L	
60961026	QT967SS		QTE967R
60961027	QT967SS	QTE967L	
60961028			

TIE ROD END INTERCHANGE TO QWIKTIE ASSEMBLY

COMPETITOR #	ASSEMBLY	LEFT*	RIGHT*
KENWORTH			
817018	QT967SS	QTE967L	
817019	QT967SS		QTE967R
1006148	QT967SS	QTE967L	
1006149	QT967SS		QTE967R
1009009	QT967SS	QTE967L	
1009010	QT967SS		QTE967R
A1-3144F370	QT108SB		QTE108R
A3144C237	QT108SB	QTE108L	
A3144C549	QT108SB	QTE108L	
A3144D238	QT108SB		QTE108R
A3144D524	QT967SS		QTE967R
A3144D550	QT108SB		QTE108R
A3144E525	QT967SS	QTE967L	
A3144F448	QT108SB		QTE108R
A3144G449	QT108SB	QTE108L	
A3144J296	QT108SB		QTE108R
A3144K297	QT108SB	QTE108L	
A3144Q225	QT967SS	QTE967L	
A3144R226	QT967SS		QTE967R
A3144U437	QT108SB	QTE108L	
A3144V438	QT108SB		QTE108R
L24SV5042A12	QT967SS		QTE967R
L24SV5043A12	QT967SS	QTE967L	
L28SV5202A1	QT108SB		QTE108R
L28SV5203A1	QT108SB	QTE108L	
MACK			
20927689	QT967SS	QTE967L	QTE967R
24426460	QT967SS	QTE967L	QTE967R
25023471	QT108SB	QTE108L	QTE108R
25168559	QT108SB	QTE108L	QTE108R
27191009009	QT967SS	QTE967L	
27191009010	QT967SS		QTE967R
10QH241P1	QT967SS		QTE967R
10QH242P1	QT967SS		QTE967R
10QH243	QT967SS		QTE967R
10QH243P1	QT967SS		QTE967R
10QH243P2	QT967SS	QTE967L	
10QH248P1	QT967SS		QTE967R
10QH248P2	QT967SS	QTE967L	
10QH248P3	QT108SB		QTE108R
10QH248P4	QT108SB	QTE108L	
10QH248P5	QT108SB		QTE108R
10QH248P6	QT108SB	QTE108L	
10QH248P7	QT967SS		QTE967R
10QH309P1	QT108SB	QTE108L	
10QH309P2	QT108SB	QTE108L	
10QH311P1	QT108SB		QTE108R
10QH312P1	QT108SB	QTE108L	
10QH39P1	QT108SB	QTE108L	
18QK214P2	QT108SB		QTE108R
18QK23A	QT108SB		QTE108R
18QK28A	QT108SB	QTE108L	
18QK29301	QT108SB		QTE108R
3102285F	QT108SB		QTE108R

COMPETITOR #	ASSEMBLY	LEFT*	RIGHT*
MACK CONT.			
3102295F	QT108SB	QTE108L	
7QH253P3	QT108SB	QTE108L	QTE108R
7QH253P4	QT108SB	QTE108L	QTE108R
7QH335	QT108SB	QTE108L	QTE108R
7QH335P2	QT108SB	QTE108L	QTE108R
7QH335P4	QT108SB	QTE108L	QTE108R
7QH335P5	QT108SB	QTE108L	QTE108R
7QH337	QT967SS	QTE967L	QTE967R
7QH337P2	QT967SS	QTE967L	QTE967R
7QH337P3	QT967SS	QTE967L	QTE967R
7QH338	QT108SB	QTE108L	QTE108R
7QH338P2	QT108SB	QTE108L	QTE108R
7QH45	QT967SS	QTE967L	QTE967R
7QH47M	QT108SB	QTE108L	QTE108R
7QH48	QT967SS	QTE967L	QTE967R
A3144E524	QT967SS		QTE967R
A3144E525	QT967SS	QTE967L	
A3144U438	QT108SB	QTE108L	
MARMON			
A3144C237	QT108SB		QTE108R
A3144D238	QT108SB	QTE108L	
A3144D524	QT967SS		QTE967R
A3144E525	QT967SS	QTE967L	
A3144J296	QT108SB		QTE108R
A3144K297	QT108SB	QTE108L	
A3144Q225	QT967SS	QTE967L	
A3144R226	QT967SS		QTE967R
A3144U437	QT108SB	QTE108L	
A3144V438	QT108SB		QTE108R
L24SV5042A12	QT967SS		QTE967R
L24SV5043A12	QT967SS	QTE967L	
MCQUAY			
ES187L	QT967SS	QTE967L	
ES187R	QT967SS		QTE967R
ES2040R	QT108SB		QTE108R
ES2041L	QT108SB	QTE108L	
ES2090L	QT108SB	QTE108L	
ES2091R	QT108SB		QTE108R
ES2113R	QT108SB		QTE108R
ES2114R	QT108SB	QTE108L	
ES2115R	QT108SB		QTE108R
ES2116L	QT108SB	QTE108L	
ES2118L	QT967SS		QTE967R
ES2202R	QT108SB		QTE108R
ES2203R	QT967SS		QTE967R
ES2204R	QT108SB		QTE108R
ES2207R	QT108SB		QTE108R
ES2209R	QT108SB		QTE108R
ES2210L	QT108SB	QTE108L	
ES2614R	QT967SS		QTE967R
ES3030R	QT108SB		QTE108R
ES3031L	QT108SB	QTE108L	
ES3176R	QT967SS		QTE967R
ES3177L	QT967SS	QTE967L	
ES3178R	QT967SS		QTE967R
ES3216R	QT967SS		QTE967R

COMPETITOR #	ASSEMBLY	LEFT*	RIGHT*
MCQUAY CONT.			
ES3217L	QT967SS	QTE967L	
ES3218R	QT967SS		QTE967R
ES3219L	QT967SS	QTE967L	
ES3220R	QT967SS		QTE967R
ES3297R	QT967SS		QTE967R
ES3298L	QT967SS	QTE967L	
ES3312R	QT967SS		QTE967R
ES3442R	QT967SS		QTE967R
ES3443L	QT967SS	QTE967L	
ES346L	QT108SB		QTE108R
ES346R	QT108SB	QTE108L	
ES3476	QT967SS		QTE967R
ES3477	QT967SS	QTE967L	
ES376L	QT108SB	QTE108L	
ES376R	QT108SB		QTE108R
ES411L	QT967SS	QTE967L	
ES411R	QT967SS		QTE967R
ES423L	QT967SS	QTE967L	
ES423R	QT967SS		QTE967R
ES431L	QT108SB		QTE108R
ES431LA	QT108SB		QTE108R
ES431R	QT108SB	QTE108L	
ES431RA	QT108SB	QTE108L	
MERITOR			
230236	QT108SB	QTE108L	
230237	QT108SB		QTE108R
1668480C91	QT108SB		QTE108R
A12103X3456	QT967SS	QTE967L	QTE967R
A13102A3459	QT967SS	QTE967L	QTE967R
A13102B3850	QT108SB	QTE108L	QTE108R
A13102C4293	QT108SB	QTE108L	QTE108R
A13102D2890	QT108SB	QTE108L	QTE108R
A13102D2890V	QT108SB	QTE108L	QTE108R
A13102D3852	QT108SB	QTE108L	QTE108R
A13102G2841	QT108SB	QTE108L	QTE108R
A13102H4532	QT967SS	QTE967L	QTE967R
A13102J3858	QT108SB	QTE108L	QTE108R
A13102J4534	QT108SB	QTE108L	QTE108R
A13102K4535	QT967SS	QTE967L	QTE967R
A13102M2899	QT108SB	QTE108L	QTE108R
A13102P3474	QT967SS	QTE967L	QTE967R
A13102P4332	QT108SB	QTE108L	QTE108R
A13102R2904	QT108SB	QTE108L	QTE108R
A13102R3450	QT967SS	QTE967L	QTE967R
A13102R4282	QT108SB	QTE108L	QTE108R
A13102R4438	QT108SB	QTE108L	QTE108R
A13102S3451	QT108SB	QTE108L	QTE108R
A13102T2802	QT108SB	QTE108L	QTE108R
A13102T3452	QT967SS	QTE967L	QTE967R
A13102T4284	QT108SB	QTE108L	QTE108R
A13102U2881	QT108SB	QTE108L	QTE108R
A13102U3869	QT108SB	QTE108L	QTE108R
A13102V2882	QT108SB	QTE108L	QTE108R
A13102V3454	QT967SS	QTE967L	QTE967R

*Only compatible with STEMCO Cross Tube QTT5773

COMPETITOR #	ASSEMBLY	LEFT*	RIGHT*
MERITOR CONT.			
A13102V4312	QT967SS	QTE967L	QTE967R
A13102W2909	QT108SB	QTE108L	QTE108R
A13102X4288	QT108SB	QTE108L	QTE108R
A13102Y3457	QT967SS	QTE967L	QTE967R
A13102Y3873	QT108SB	QTE108L	QTE108R
A13102Z3458	QT967SS	QTE967L	QTE967R
A13102Z3874	QT108SB	QTE108L	QTE108R
A23102A3459	QT967SS	QTE967L	QTE967R
A23102C3456	QT967SS	QTE967L	QTE967R
A23102F3464	QT967SS	QTE967L	QTE967R
A23102G3465	QT967SS	QTE967L	QTE967R
A23102H4558	QT967SS	QTE967L	QTE967R
A23102J4560	QT967SS	QTE967L	QTE967R
A23102K379	QT967SS	QTE967L	QTE967R
A23102L4380	QT967SS	QTE967L	QTE967R
A23102N3472	QT967SS	QTE967L	QTE967R
A23102P3474	QT967SS	QTE967L	QTE967R
A23102Q4229	QT967SS	QTE967L	QTE967R
A23102R3450	QT967SS	QTE967L	QTE967R
A23102R3476	QT967SS	QTE967L	QTE967R
A23102S3451	QT108SB	QTE108L	QTE108R
A23102T3452	QT967SS	QTE967L	QTE967R
A23102V3454	QT967SS	QTE967L	QTE967R
A23102V4312	QT967SS	QTE967L	QTE967R
A23102W3455	QT967SS	QTE967L	QTE967R
A23102Y3457	QT967SS	QTE967L	QTE967R
A23102Y3483	QT967SS	QTE967L	QTE967R
A23102Y3847	QT108SB	QTE108L	QTE108R
A23102Y3873	QT108SB	QTE108L	QTE108R
A23102Z3458	QT967SS	QTE967L	QTE967R
A23102Z3874	QT108SB	QTE108L	QTE108R
A23144J192	QT967SS		QTE967R
A23144K193	QT967SS	QTE967L	
A3144A547	QT108SB	QTE108L	
A3144C237	QT108SB	QTE108L	
A3144C549	QT108SB	QTE108L	
A3144D238	QT108SB		QTE108R
A3144D524	QT967SS		QTE967R
A3144D550	QT108SB		QTE108R
A3144E525	QT967SS	QTE967L	
A3144F448	QT108SB		QTE108R
A3144F526	QT967SS		QTE967R
A3144F522	QT967SS		QTE967R
A3144G449	QT108SB	QTE108L	
A3144G553	QT967SS	QTE967L	
A3144J296	QT108SB	QTE108L	
A3144K296	QT108SB		QTE108R
A3144K297	QT108SB	QTE108L	
A3144N534	QT967SS	QTE967L	
A3144P458	QT967SS		QTE967R
A3144Q225	QT967SS	QTE967L	
A3144Q459	QT967SS		QTE967R
A3144R226	QT967SS		QTE967R
A3144U437	QT108SB	QTE108L	

COMPETITOR #	ASSEMBLY	LEFT*	RIGHT*
MERITOR CONT.			
A3144V1088	QT967SS		QTE967R
A3144V1089	QT967SS	QTE967L	
A3144V438	QT108SB		QTE108R
A3144W1141	QT967SS	QTE967L	
A3144X1142	QT967SS		QTE967R
A3144Z546	QT108SB		QTE108R
A3302V3454V	QT967SS	QTE967L	QTE967R
A33102L4380	QT967SS	QTE967L	QTE967R
A33102N3472	QT967SS	QTE967L	QTE967R
A33102V3454	QT967SS	QTE967L	QTE967R
A33102Z3484	QT967SS		

TIE ROD END INTERCHANGE TO QWIKTIE ASSEMBLY

COMPETITOR #	ASSEMBLY	LEFT*	RIGHT*
MISC. CONT.			
1006151	QT967SS	QTE967L	QTE967R
1006734	QT967SS	QTE967L	QTE967R
21639955	QT967SS	QTE967L	QTE967R
25160398	QT108SB	QTE108L	QTE108R
25161090	QT108SB	QTE108L	QTE108R
370045017	QT967SS	QTE967L	QTE967R
MOOG			
ES187L	QT967SS	QTE967L	
ES187R	QT967SS		QTE967R
ES2040R	QT108SB		QTE108R
ES2041L	QT108SB	QTE108L	
ES2090L	QT108SB	QTE108L	
ES2091R	QT108SB		QTE108R
ES2113R	QT108SB		QTE108R
ES2114R	QT108SB		QTE108R
ES2115R	QT108SB		QTE108R
ES2116L	QT108SB	QTE108L	
ES2118L	QT967SS		QTE967R
ES2202R	QT108SB		QTE108R
ES2203R	QT967SS		QTE967R
ES2204R	QT108SB		QTE108R
ES2207R	QT108SB		QTE108R
ES2208R	QT108SB		QTE108R
ES2209R	QT108SB		QTE108R
ES2210L	QT108SB	QTE108L	
ES2215R	QT108SB	QTE108L	
ES2614R	QT967SS		QTE967R
ES3030R	QT108SB		QTE108R
ES3031L	QT108SB	QTE108L	
ES3041R	QT967SS		QTE967R
ES3056	QT108SB		QTE108R
ES3057	QT108SB	QTE108L	
ES3176R	QT967SS		QTE967R
ES3177L	QT967SS	QTE967L	
ES3178R	QT967SS		QTE967R
ES3216R	QT967SS		QTE967R
ES3217L	QT967SS	QTE967L	
ES3218R	QT967SS		QTE967R
ES3219L	QT967SS	QTE967L	
ES3220R	QT967SS		QTE967R
ES3297R	QT967SS		QTE967R
ES3298L	QT967SS	QTE967L	
ES3442R	QT967SS		QTE967R
ES3443L	QT967SS	QTE967L	
ES346L	QT108SB		QTE108R
ES346R	QT108SB	QTE108L	
ES3476	QT967SS		QTE967R
ES3477	QT967SS	QTE967L	
ES376L	QT108SB	QTE108L	
ES376R	QT108SB		QTE108R
ES411L	QT967SS	QTE967L	
ES411R	QT967SS		QTE967R
ES423R	QT967SS		QTE967R
ES431L	QT108SB		QTE108R

COMPETITOR #	ASSEMBLY	LEFT*	RIGHT*
MOOG CONT.			
ES431LA	QT108SB		QTE108R
ES431LS	QT108SB		QTE108R
ES431R	QT108SB	QTE108L	
ES431RA	QT108SB	QTE108L	
ES461RS	QT108SB	QTE108L	
ES9009	QT967SS	QTE967L	
MOTORCRAFT			
MEOE102	QT108SB		QTE967R
MEOE139	QT967SS	QTE967L	
MEOE180	QT108SB		QTE967R
MEOE22	QT967SS	QTE967L	QTE967R
NAVISTAR			
817018	QT967SS	QTE967L	
817019	QT967SS		QTE967R
110362R92	QT967SS	QTE967L	
110363R92	QT967SS		QTE967R
140TR109	QT967SS	QTE967L	
140TR111	QT967SS	QTE967L	
140TR112	QT967SS		QTE967R
1649637C91	QT967SS	QTE967L	
1649638C91	QT108SB		QTE967R
1668407C91	QT967SS	QTE967L	
1668408C91	QT967SS		QTE967R
1668409C91	QT967SS	QTE967L	
1668410C91	QT967SS		QTE967R
1668479C91	QT108SB	QTE108L	
1668480C91	QT108SB		QTE108R
1677271C91	QT108SB		QTE108R
220TR118	QT108SB	QTE108L	
220TR119	QT108SB		QTE108R
2597100C91	QT967SS	QTE967L	QTE967R
2603967C91	QT108SB		QTE967R
2603968C91	QT967SS	QTE967L	
377635C91	QT967SS	QTE967L	
377636C91	QT967SS		QTE967R
438368C91	QT967SS	QTE967L	
438369C91	QT967SS		QTE967R
442354C91	QT108SB		QTE108R
447094C91	QT967SS	QTE967L	
447095C91	QT108SB		QTE967R
461665C91	QT108SB		QTE108R
461672C91	QT108SB		QTE967R
468354C91	QT108SB	QTE108L	
477094C91	QT967SS	QTE967L	
477095C91	QT967SS		QTE967R
486354C91	QT108SB	QTE108L	
486355C91	QT108SB		QTE108R
486355C91F	QT108SB		QTE108R
486355R91	QT108SB		QTE108R
486807C91	QT108SB		QTE967R
491665C91	QT108SB		QTE108R
491666C91	QT108SB		QTE108R
506662C91	QT108SB		QTE967R
506684C91	QT108SB		QTE108R

COMPETITOR #	ASSEMBLY	LEFT*	RIGHT*
NAVISTAR CONT.			
507835C91	QT967SS	QTE967L	
507836C91	QT967SS		QTE967R
507837C91	QT967SS	QTE967L	
507838C91	QT967SS		QTE967R
549772C91	QT108SB	QTE108L	QTE108R
581063C91	QT108SB		QTE108R
590583C91	QT108SB		QTE108R
590584C91	QT108SB	QTE108L	
596653C91	QT967SS		QTE967R
64002-001	QT967SS	QTE967L	
64002-002	QT967SS		QTE967R
969055R91	QT108SB	QTE108L	
969056R91	QT108SB		QTE108R
FTR187L	QT967SS	QTE967L	
FTR187R	QT967SS		QTE967R
FTR2040R	QT108SB		QTE108R
FTR2090L	QT108SB	QTE108L	
FTR2091R	QT108SB		QTE108R
FTR2113R	QT108SB		QTE108R
FTR2114R	QT108SB		QTE108R
FTR2115R	QT108SB		QTE108R
FTR2116L	QT108SB	QTE108L	
FTR2202R	QT108SB		QTE108R
FTR2203R	QT108SB		QTE967R
FTR2204R	QT108SB		QTE108R
FTR2207R	QT108SB		QTE108R
FTR2209R	QT108SB		QTE108R
FTR2210L	QT108SB	QTE108L	
FTR2614R	QT967SS		QTE967R
FTR3030R	QT108SB		QTE108R
FTR3031L	QT108SB	QTE108L	
FTR3033L	QT108SB		QTE108R
FTR3057	QT108SB	QTE108L	
FTR346L	QT108SB		QTE108R
FTR346R	QT108SB	QTE108L	
FTR3476	QT967SS		QTE967R
FTR3477	QT108SB	QTE967L	
FTR376L	QT108SB	QTE108L	
FTR376R	QT108SB		QTE108R
FTR411L	QT967SS	QTE967L	
FTR411R	QT967SS		QTE967R
FTR423L	QT967SS	QTE967L	
FTR423R	QT967SS		QTE967R
FTR431L	QT108SB		QTE108R
FTR431R	QT108SB	QTE108L	
FTR487L	QT967SS	QTE967L	
FTR8407	QT967SS	QTE967L	
FTR8408	QT967SS		QTE967R
FTR8409	QT967SS	QTE967L	
FTR8410	QT967SS		QTE967R
O&S MFG.			
ES2040R	QT108SB		QTE108R
ES2041L	QT108SB	QTE108L	
ES2090L	QT108SB	QTE108L	

*Only compatible with STEMCO Cross Tube QTT5773

COMPETITOR #	ASSEMBLY	LEFT*	RIGHT*
O&S MFG. CONT.			
ES2091R	QT108SB		QTE108R
ES2118L	QT967SS		QTE967R
ES2207R	QT108SB		QTE108R
ES2208R	QT108SB		QTE108R
ES346L	QT108SB		QTE108R
ES346R	QT108SB	QTE108L	
ES376L	QT108SB	QTE108L	
ES376R	QT108SB		QTE108R
ES411L	QT967SS	QTE967L	
ES411R	QT967SS		QTE967R
ES423L	QT967SS	QTE967L	
ES423R	QT967SS		QTE967R
ES431R	QT108SB	QTE108L	
PAI			
2692235	QT967SS		QTE967R
ARE9950	QT108SB	QTE108L	
ARE9955	QT967SS		QTE967R
ARE9984	QT967SS	QTE967L	
ARE9985	QT967SS		QTE967R
ARE9986	QT108SB		QTE108R
ARE9988	QT967SS		QTE967R
ARE9989	QT967SS	QTE967L	
ARE9990	QT108SB		QTE108R
ARE9991	QT108SB		QTE108R
PERFECT CIRCLE			
2692041	QT967SS	QTE967L	
2692042	QT967SS		QTE967R
2692158	QT108SB		QTE108R
2692159	QT108SB	QTE108L	
2692234	QT967SS	QTE967L	
2692235	QT967SS		QTE967R
2692243	QT967SS	QTE967L	
2692244	QT967SS		QTE967R
2692311	QT108SB	QTE108L	
2692312	QT108SB	QTE108L	
2692446	QT108SB	QTE108L	
2692447	QT108SB		QTE108R
2692485	QT108SB		QTE108R
2692644	QT108SB	QTE108R	
2692645	QT108SB	QTE108L	
2692653	QT967SS		QTE967R
2692663	QT967SS		QTE967R
2692698	QT108SB	QTE108R	
2692699	QT108SB	QTE108R	
2692700	QT108SB	QTE108R	
2692705	QT967SS	QTE967R	
2692709	QT108SB	QTE108R	
2692710	QT108SB	QTE108R	
2693039	QT967SS	QTE967R	
2693040	QT967SS	QTE967L	
2695098	QT108SB		QTE108R
2962311	QT108SB		QTE108R
3693034	QT967SS	QTE967L	
S7460	QT967SS		QTE967R

COMPETITOR #	ASSEMBLY	LEFT*	RIGHT*
S&S			
S4760	QT108SB		QTE108R
S5048	QT108SB	QTE108L	
S5049	QT108SB		QTE108R
S5056	QT967SS	QTE967L	
S5057	QT967SS		QTE967R
S5988	QT108SB		QTE108R
S6659	QT108SB	QTE108R	
S7357	QT967SS		QTE967R
S7358	QT967SS	QTE967L	
S7459	QT967SS	QTE967L	
S7460	QT967SS		QTE967R
S8999	QT967SS	QTE967L	
S9000	QT967SS		QTE967R
SPICER			
806962	QT967SS	QTE967L	QTE967R
813975	QT967SS	QTE967L	QTE967R
815326	QT967SS	QTE967L	QTE967R
815327	QT967SS	QTE967L	QTE967R
817018	QT967SS		QTE967R
817019	QT967SS		QTE967R
817755	QT108SB	QTE108L	QTE108R
818462	QT967SS	QTE967L	QTE967R
820623	QT108SB	QTE108L	QTE108R
820625	QT108SB	QTE108L	QTE108R
820677	QT108SB	QTE108L	QTE108R
822073	QT108SB	QTE108L	QTE108R
822074	QT108SB	QTE108L	QTE108R
822076	QT108SB	QTE108L	QTE108R
822077	QT108SB	QTE108L	QTE108R
917018	QT967SS	QTE967	

TIE ROD END INTERCHANGE TO QWIKTIE ASSEMBLY

COMPETITOR #	ASSEMBLY	LEFT*	RIGHT*
SPICER CONT.			
TRE3476R	QT967SS		QTE967R
TRE3477L	QT967SS	QTE967L	
TRE411L	QT967SS	QTE967L	
TRE411R	QT967SS		QTE967R
TRE431BLA	QT108SB		QTE108R
TRE431BRA	QT108SB	QTE108L	
TRE431SLA	QT108SB		QTE108R
TRE431SRA	QT108SB	QTE108L	
TRE476R	QT967SS		QTE967R
THOMAS BUILT BUSES			
61110153	QT108SB		QTE967R
61110154	QT967SS	QTE967L	
TRAILMOBILE			
384614	QT967SS	QTE967L	
384615	QT967SS		QTE967R
384616	QT108SB	QTE108L	
TRP			
TE10001	QT967SS		QTE967R
TE10002	QT967SS	QTE967L	
TE11003	QT967SS		QTE967R
TE11004	QT967SS	QTE967L	
TE11007	QT967SS		QTE967R
TE11008	QT967SS	QTE967L	
TE11981	QT967SS		QTE967R
TE11982	QT967SS	QTE967L	
TE11987	QT967SS		QTE967R
TE11988	QT967SS	QTE967L	
TE12007	QT108SB	QTE108L	
TE12008	QT108SB		QTE108R
TE12011	QT108SB	QTE108R	
TE12039	QT108SB		QTE108R
TRW			
ES3476	QT967SS		QTE967R
ES3477	QT967SS	QTE967L	
ES2040R	QT108SB		QTE108R
ES2041L	QT108SB	QTE108R	
ES2090L	QT108SB		QTE108R
ES2091R	QT108SB	QTE108R	
ES2113R	QT108SB		QTE108R
ES2114R	QT108SB	QTE108R	
ES2115R	QT108SB		QTE108R
ES2116L	QT108SB	QTE108L	
ES2118L	QT967SS		QTE967R
ES2202R	QT108SB		QTE108R
ES2204R	QT108SB	QTE108R	
ES2207R	QT108SB		QTE108R
ES2208R	QT108SB	QTE108R	
ES2209R	QT108SB		QTE108R
ES2210L	QT108SB	QTE108L	
ES2614R	QT967SS		QTE967R
ES3030R	QT108SB		QTE108R
ES3031L	QT108SB	QTE108L	
ES3033L	QT108SB	QTE108L	
ES3034R	QT108SB		QTE108R

COMPETITOR #	ASSEMBLY	LEFT*	RIGHT*
TRW CONT.			
ES3057	QT108SB		QTE108L
ES3176R	QT967SS		QTE967R
ES3177L	QT967SS	QTE967L	
ES3218R	QT967SS		QTE967R
ES3219L	QT967SS	QTE967L	
ES3220R	QT967SS		QTE967R
ES3297R	QT967SS		QTE967R
ES3298L	QT967SS	QTE967L	
ES3442R	QT967SS		QTE967R
ES3443L	QT967SS	QTE967L	
ES346L	QT108SB		QTE108R
ES346R	QT108SB	QTE108L	
ES3476	QT967SS		QTE967R
ES3477	QT967SS	QTE967L	
ES376L	QT108SB	QTE108L	
ES376R	QT108SB		QTE108R
ES411L	QT967SS	QTE967L	
ES411R	QT967SS		QTE967R
ES423L	QT967SS	QTE967L	
ES423R	QT967SS		QTE967R
ES431L	QT108SB	QTE108L	
ES431R	QT108SB		QTE108R
L18RT0734A18	QT967SS	QTE967L	QTE967R
L20LV8041A13	QT967SS	QTE967L	
L20LV8041A14	QT967SS	QTE967L	
L20LV8041A15	QT967SS	QTE967L	
L20LV8042A13	QT967SS		QTE967R
L20LV8042A14	QT967SS		QTE967R
L20LV8042A15	QT967SS		QTE967R
L20LV8087A13	QT967SS	QTE967L	
L20LV8088A13	QT967SS		QTE967R
L20LV8128B12	QT967SS	QTE967L	
L20LV8129B12	QT967SS		QTE967R
L20LV8165A14	QT967SS	QTE967L	
L20LV8166A14	QT967SS		QTE967R
L20SV5180B14	QT967SS		QTE967R
L20SV5181B14	QT967SS	QTE967L	
L20SV8100B13	QT967SS	QTE967L	
L20SV8100C14	QT967SS	QTE967L	
L20SV8100D12	QT967SS	QTE967L	
L20SV8101B12	QT967SS		QTE967R
L20SV8101B15	QT967SS		QTE967R
L20SV8101C15	QT967SS		QTE967R
L20SV8101D12	QT967SS	QTE967L	
L20SV8102D16	QT967SS	QTE967L	
L20SV8102F13	QT967SS	QTE967L	
L20SV8102K11	QT967SS		QTE967R
L20SV8103K11	QT967SS	QTE967L	
L20SV8104B14	QT967SS	QTE967L	
L20SV8104B16	QT967SS	QTE967L	
L20SV8105B14	QT967SS		QTE967R
L20SV8105B16	QT967SS		QTE967R
L20SV8107C12	QT967SS	QTE967L	
L20SV8108A13	QT967SS		QTE967R

COMPETITOR #	ASSEMBLY	LEFT*	RIGHT*
TRW CONT.			
L20SV8109A12	QT967SS		QTE967R
L20SV8110A17	QT967SS		QTE967R
L20SV8111A15	QT967SS	QTE967L	
L20SV8115A12	QT967SS	QTE967L	
L20SV8116A12	QT967SS		QTE967R
L20SV8132B12	QT967SS		QTE967R
L20SV8150A13	QT967SS		QTE967R
L20SV8150B16	QT967SS		QTE967R
L20SV8151A13	QT967SS	QTE967L	
L20SV8151B16	QT967SS	QTE967L	
L20SV8256A14	QT967SS		QTE967R
L20VT8263A11	QT967SS	QTE967L	QTE967R
L24LV5324A12	QT967SS		QTE967R
L24LV5325A12	QT967SS	QTE967L	
L24LV8441A13	QT967SS	QTE967L	
L24LV8442A13	QT967SS		QTE967R
L24SV5042B12	QT967SS	QTE967L	
L24SV5042D14	QT967SS		QTE967R
L24SV5043A12	QT967SS		QTE967R
L24SV5043B12	QT967SS	QTE967L	
L24SV5044A12	QT967SS		QTE967R
L24SV5202A11	QT108SB		QTE108R
L24SV7002C12	QT967SS		QTE967R
L24SV8000C20	QT967SS	QTE967L	
L24SV8000E13	QT967SS	QTE967L	
L24SV8001E13	QT967SS		QTE967R
L24SV8002C13	QT967SS	QTE967L	
L24SV8100B13	QT108SB	QTE108L	
L24SV8100D12	QT967SS	QTE967L	
L24SV8100D18	QT967SS	QTE967L	
L24SV8101A21	QT108SB		QTE108R
L24SV8101A23	QT108SB		QTE108R
L24SV8101C22	QT108SB	QTE108R	
L24SV8101E16	QT967SS		QTE967R
L24SV8101E19	QT967SS		QTE967R
L24SV8102C13	QT108SB	QTE108L	
L24SV8102C15	QT108SB	QTE108L	
L24SV8103C1	QT108SB		QTE108R
L24SV8103C12	QT108SB		QTE108R
L24SV8107A13	QT108SB	QTE108L	
L24SV8110D12	QT108SB		QTE108R
L24SV8202D18	QT108SB	QTE108L	
L24SV8203B18	QT108SB		QTE108R
L24SV8204A19	QT108SB		QTE108R
L24SV8205C13	QT967SS	QTE967L	
L24SV8205C25	QT108SB	QTE108L	
L24SV8207A14	QT108SB	QTE108L	
L24SV8208B12	QT108SB	QTE108L	
L24SV8209B12	QT108SB	QTE108L	
L24SV8210A13	QT108SB	QTE108L	
L24SV8210A27	QT108SB		QTE108R
L24SV8211A16	QT108SB		QTE108R
L24SV8211B12	QT108SB	QTE108L	
L24SV8214B15	QT108SB		QTE108R

*Only compatible with STEMCO Cross Tube QTT5773

COMPETITOR #	ASSEMBLY	LEFT*	RIGHT*
TRW CONT.			
L24SV8312A13	QT967SS		QTE967R
L24SV8334A14	QT967SS		QTE967R
L24SV8339A12	QT967SS	QTE967L	
L24SV8348A12	QT967SS		QTE967R
L24SV8454A14	QT108SB		QTE108R
L24SV8454A16	QT108SB		QTE108R
L24SV8454A19	QT108SB		QTE108R
L24SV8455A14	QT108SB	QTE108L	
L24SV8455A16	QT108SB	QTE108L	
L24SV8455A19	QT108SB	QTE108L	
L24VT8003BAA	QT967SS	QTE967L	QTE967R
L24VT8234C11	QT967SS	QTE967L	QTE967R
L24VT8998A11	QT108SB	QTE108L	QTE108R
L28SV5201A11	QT108SB	QTE108L	
L28SV5201A12	QT108SB	QTE108L	
L28SV5202A11	QT108SB		QTE108R
L28SV5202A16	QT108SB		QTE108R
L28SV5207B16	QT108SB		QTE108R
L28SV5211B23	QT108SB		QTE108R
L28SV5211B37	QT108SB		QTE108R
L28SV5275A12	QT108SB	QTE108L	
L28SV5276A12	QT108SB		QTE108R
L28SV5326A14	QT108SB		QTE108R
UNIMOTIVE			
TR187L	QT967SS	QTE967L	
TR187R	QT967SS		QTE967R
TR2040R	QT108SB		QTE108R
TR2041L	QT108SB	QTE108L	
TR2090L	QT108SB	QTE108L	
TR2091R	QT108SB		QTE108R
TR2113R	QT108SB		QTE108R
TR2114R	QT108SB		QTE108R
TR2115R	QT108SB		QTE108R
TR2116L	QT108SB	QTE108L	
TR2118L	QT967SS		QTE967R
TR2202R	QT108SB		QTE108R
TR2204R	QT108SB		QTE108R
TR2207R	QT108SB		QTE108R
TR2209R	QT108SB		QTE108R
TR2210L	QT108SB	QTE108L	
TR346L	QT108SB		QTE108R
TR346R	QT108SB	QTE108L	
TR376L	QT108SB	QTE108L	
TR376R	QT108SB		QTE108R
TR411L	QT967SS	QTE967L	
TR411R	QT967SS		QTE967R
TR423L	QT967SS	QTE967L	
TR423R	QT967SS		QTE967R
TR431R	QT108SB	QTE108L	
URRESKO			
USK-0004R	QT108SB		QTE108R
USK-0005L	QT108SB	QTE108L	
USK-12007R	QT108SB		QTE108R
USK-12008L	QT108SB	QTE108L	

COMPETITOR #	ASSEMBLY	LEFT*	RIGHT*
URRESKO CONT.			
USK-128187R	QT967SS		QTE967R
USK-12889R	QT967SS		QTE967R
USK-12890L	QT967SS	QTE967L	
USK-13R	QT967SS		QTE967R
USK-147R	QT108SB		QTE108R
USK-14L	QT967SS	QTE967L	
USK-14R	QT967SS		QTE967R
USK-156R	QT108SB		QTE108R
USK-157R	QT108SB		QTE108R
USK-167R	QT108SB		QTE108R
USK-187L	QT967SS	QTE967L	
USK-187R	QT967SS		QTE967R
USK-2090L	QT108SB	QTE108L	
USK-2091R	QT108SB		QTE108R
USK-2203R	QT967SS		QTE967R
USK-2207R	QT108SB		QTE108R
USK-2208R	QT108SB		QTE108R
USK-2290L	QT108SB	QTE108L	
USK-2291R	QT108SB		QTE108R
USK-248P1R	QT967SS		QTE967R
USK-248P2L	QT967SS	QTE967L	
USK-248P3R	QT108SB		QTE108R
USK-248P4L	QT108SB	QTE108L	
USK-248P5R	QT108SB		QTE108R
USK-248P			

TIE ROD END INTERCHANGE TO QWIKTIE ASSEMBLY

COMPETITOR #	ASSEMBLY	LEFT*	RIGHT*
VOLVO / WHITE CONT.			
838308B	QT108SB	QTE108L	
839307B	QT108SB		QTE108R
839308B	QT108SB	QTE108L	
A13144F370	QT108SB		QTE108R
A3144C237	QT108SB	QTE108L	
A3144C549	QT108SB	QTE108L	
A3144D238	QT108SB		QTE108R
A3144D524	QT967SS		QTE967R
A3144D550	QT108SB		QTE108R
A3144E525	QT967SS	QTE967L	
A3144J296	QT108SB		QTE108R
A3144J297	QT108SB		QTE108R
A3144K297	QT108SB	QTE108L	
A3144K298	QT108SB	QTE108L	
A3144K298	QT108SB		QTE108R
A3144Q225	QT967SS	QTE967L	
A3144R226	QT967SS		QTE967R
A3144U437	QT108SB		QTE108R
A3144U438	QT108SB	QTE108L	
A3144V437	QT108SB		QTE108R
A3144V438	QT108SB	QTE108L	
V1091562	QT967SS	QTE967L	
V1091563	QT108SB		QTE967R
V1110067	QT108SB	QTE108L	
V1110068	QT108SB		QTE108R
V111067	QT108SB		QTE108R
V111068	QT108SB	QTE108L	
V1112818	QT967SS	QTE967L	
WESTERN STAR			
1006148	QT967SS		QTE967R
1006149	QT967SS	QTE967L	
1009009	QT967SS	QTE967L	
1009010	QT967SS		QTE967R
370035029	QT108SB	QTE108L	
370035031	QT108SB		QTE108R
370244412	QT967SS		QTE967R
1436400021	QT108SB	QTE108L	QTE108R
1436400022	QT108SB	QTE108L	QTE108R
1436400036	QT967SS	QTE967L	QTE967R
1436400037	QT967SS	QTE967L	QTE967R
A3144C549	QT108SB	QTE108L	
A3144D550	QT108SB		QTE108R
A3144F448	QT108SB		QTE108R
A3144G449	QT108SB	QTE108L	
WESTPORT			
143640-005	QT108SB		QTE108R
37025-0004	QT967SS	QTE967L	
37025-0005	QT967SS		QTE967R
839307B	QT108SB		QTE108R
839308B	QT108SB	QTE108L	
WORKHORSE			
W8001028	QT108SB	QTE108L	
W8001029	QT108SB		QTE108R

TIE ROD END REFERENCE

QTE967 R – L (small taper – Green cap)
 Thread Diameter 1 1/8" Minor OD on taper 0.967"
 Including ES2203R, ES3442R, ES3443L
 QTE108 R – L (big taper – Red cap)
 Thread Diameter 1 1/4" Minor OD on taper 1.080" Including ES5945R, ES5945L

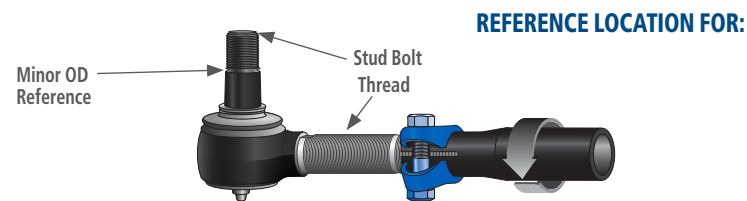

FRONT STEERING AXLE

STEMCO Kaiser NO REAM king pin repairs do not require the complete removal of the spindle. Tear the unit down until the bushings can be removed. Be sure the spindles are clean and free from burrs prior to installing the bushings. Spiral bushings are easily installed by hand. After bushings are installed use the king pin to check for proper fit and clearance prior to placing the spindle back on the axle. Be sure and follow the installation instruction in the kit.

NO King Pin can repair worn axle or spindle eyes.
 Axle eyes can be repaired with the

AXLE • PRO • EQUIPMENT



STEMCO KAISER QWIKKITS COME COMPLETE

A TYPICAL KIT CONSISTS OF:

- 2 - STEMCO Kaiser king pins
- 2 or 4 - STEMCO Kaiser bushings
- 2 - Thrust bearings
- 1 - Package of steel shim spacers
- 2 or 4 - Lock pins (depending upon axle design)
- 4 - End plates and seals
- 1 - Package of cap screws and washers

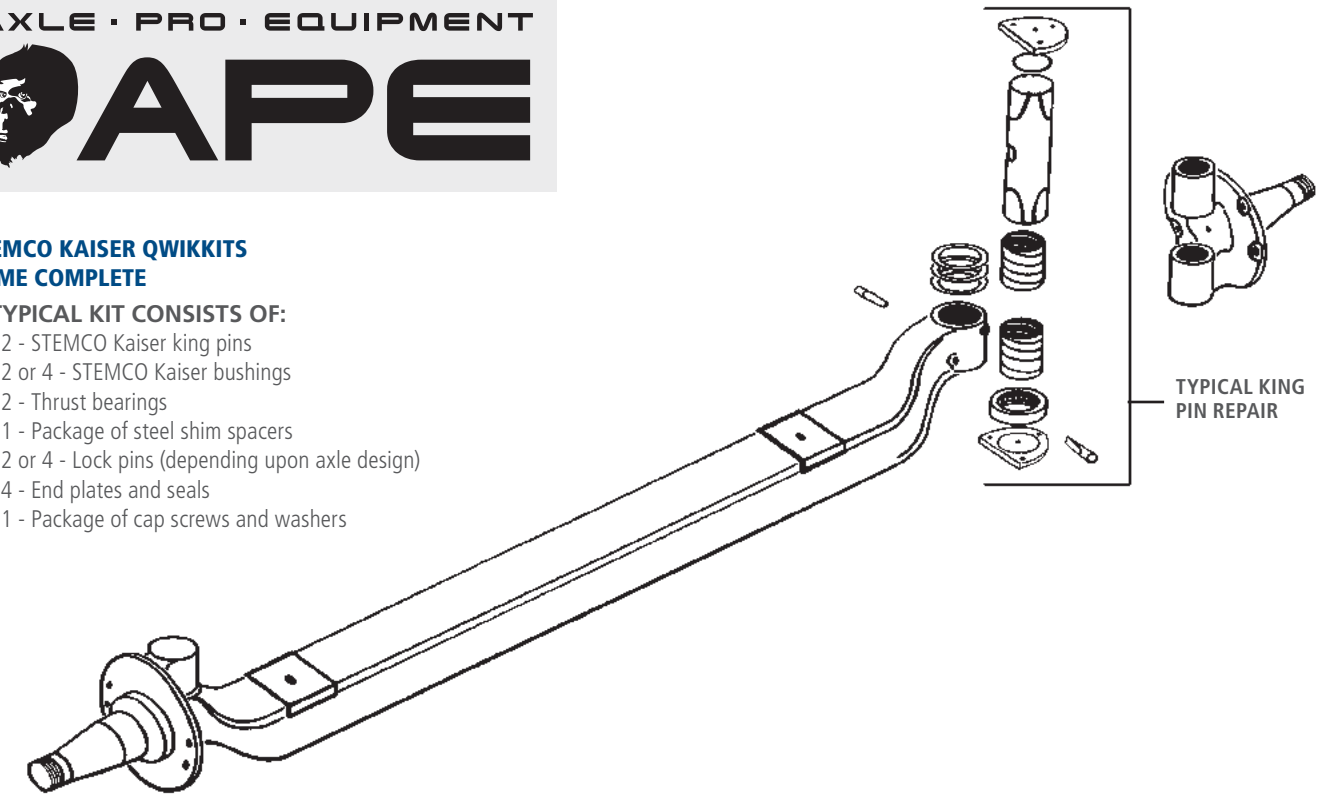

STEMCO Kaiser Spiral Steel Bushing must be used with STEMCO Kaiser grease grooved king pin.

AXLE PRO EQUIPMENT CROSS-REFERENCE MATRIX



AXLE CODE	KING PIN KIT #	APE MASTER KIT #	APE CUTTER KIT #	APE REPLACEMENT CUTTER KIT #	APE CUTTER #	APE REAMER #	SLEEVE DRIVER #	APE SLEEVE #
W8002502	K50W	85.056.07	84.056.07	87.056.07	83.056.07	82.056.07	ST70-4T	91.050.23
F-050, F-055	K55G & K56G	85.056.07	84.056.07	87.056.07	83.056.07	82.056.07	ST70-4T	91.056.07
MFS-06	K60R	N/A	84.060.18 ★	N/A	83.060.18	82.060.18	ST70-3T	91.060.18
ISUZU NPR 1990-1998	K68Z	85.056.07	84.056.07	87.056.07	83.056.07	82.056.07	ST70-4T	91.068.26
ISUZU NPR 1998-PRESENT	K69Z	85.056.07	84.056.07	87.056.07	83.056.07	82.056.07	ST70-4T	91.068.26
MFS-08	K80R	N/A	84.080.18 ★	N/A	83.080.18	82.080.18	ST70-28T	92.080.18
FA-101, FA-104	K101I	85.103.19	84.103.19	87.103.19	83.103.19	82.103.19	ST70-2T	91.101.09
O2ADA, O2ADB, O2AEM BEFORE 10-1-2002	K102I	85.103.19	84.103.19	87.103.19	83.103.19	82.103.19	ST70-2T	92.102.09
O2AEM AFTER 10-1-2002	K103S	85.103.19	84.103.19	87.103.19	83.103.19	82.103.19	ST70-2T	93.103.19
EFA12F4	K120E	85.120.05	84.120.05	87.120.05	83.120.05	82.120.05	ST70-6T	91.120.05
AF-10.0-3, AF-12.0-3, AF-13.0-3, AF-13.3-3, AF-14.7-3	K120A	85.122.05	84.122.05	87.122.05	83.122.05	82.122.05	ST70-30T	92.120.01
O2-ADC, O2-ADD, I-100S I-120S, I-120SG	K120I	85.147.05	84.147.05	87.147.05	83.147.05	82.147.05	ST70-19T	92.120.09
E1000, E1200, E1201, E1320	K122E	85.122.05	84.122.05	87.122.05	83.122.05	82.122.05	ST70-7T	91.122.05
O2-AGA, E1203I	K123E	85.122.05	84.122.05	87.122.05	83.122.05	82.122.05	ST70-7T	93.123.05
F3W-1300, F3W-1400 WITH BOLT ON CAPS	K126W	85.122.05	84.122.05	87.122.05	83.122.05	82.122.05	ST70-33T	91.127.23
F3W-1300, F3W-1400 WITH SCREW IN CAP	K127W	85.122.05	84.122.05	87.122.05	83.122.05	82.122.05	ST70-33T	91.127.23
WATSON CHALIN 1100 SERIES WITH WESTPORT AXLE	K130W	85.122.05	84.122.05	87.122.05	83.122.05	82.122.05	ST70-7T	91.961.12
DUARALIFT & MODEL 9000	K132K	85.122.05	84.122.05	87.122.05	83.122.05	82.122.05	ST70-7T	91.132.11
FA-118, FA-127, FA-139, FA-329, FA-337, FA-339, FA-342, FA-343, I-108, I-120, I-132, I-132S ALL ABOVE APPLICATIONS 1982 AND NEWER	K140I	85.120.05	84.120.05	87.120.05	83.120.05	82.120.05	ST70-5T	92.140.09

★ This cutter kit is not included in 85.999.99 or 95.999.99

For tighter fitting bushings, consider ordering any of the APE kits, or sleeves in the tight fit configuration by adding a letter 'T' to the end of the part number. Carbide Reamers are available for extreme applications.



AXLE CODE	KING PIN KIT #	APE MASTER KIT #	APE CUTTER KIT #	APE REPLACEMENT CUTTER KIT #	APE CUTTER #	APE REAMER #	SLEEVE DRIVER #	APE SLEEVE #
E1460	K146E	85.147.05	84.147.05	87.147.05	83.147.05	82.147.05	ST70-23T	91.146.05
E1002, E1202, E1322, E1462	K147E	85.147.05	84.147.05	87.147.05	83.147.05	82.147.05	ST70-23T	93.147.05
KIMBLE	K149E	85.147.05	84.147.05	87.147.05	83.147.05	82.147.05	ST70-23T	93.147.05
KGS150	K150KG	85.931.12	84.931.12	87.931.12	83.931.12	82.931.12	ST70-12T	91.150.07
O2-ADH, O2-AEU, O2-AEV, O2-AEW, O2-ADJ, O2-ADK, I-160S, I-160W, I-180S, I-180W, I-200S, I-220S, I-220W	K160S	85.931.12	84.931.12	87.931.12	83.931.12	82.931.12	ST70-24T	92.160.19
EFA18F3, EFA18F4, EFA20F4, EFA22T2	K180E	85.147.05	84.147.05	87.147.05	83.147.05	82.147.05	ST70-23T	91.180.05
MFS-16122A, MFS-16143A, MFS-18133A	K180R	85.931.12	84.931.12	87.931.12	83.931.12	82.931.12	ST70-12T	92.180.18
MFS16133A, MFS18133A, MFS20133A	K181R	85.931.12	84.931.12	87.931.12	83.931.12	82.931.12	ST70-12T	92.931.12
D2000F, D2200F	K201S	85.931.12	84.931.12	87.931.12	83.931.12	82.931.12	ST70-24T	93.201.19
KGS230	K230KG	85.700.20	84.700.20 ★	87.700.20	83.700.20	82.700.20	ST70-29T	94.230.07
700214	K700T	85.700.20	84.700.20 ★	87.700.20	83.700.20	82.700.20	ST70-29T	92.700.20
FF-921, FF-923	K921L	85.122.05	84.122.05	87.122.05	83.122.05	82.122.05	ST70-7T	92.961.12
FF-931	K931L	85.122.05	84.122.05	87.122.05	83.122.05	82.122.05	ST70-7T	92.961.12
	K941F	85.122.05	84.122.05	87.122.05	83.122.05	82.122.05	ST70-7T	92.942.06
	K942F	85.122.05	84.122.05	87.122.05	83.122.05	82.122.05	ST70-7T	92.942.06
WATSON CHALIN 1100 SERIES WITH MERITOR AXLE	K961L	85.122.05	84.122.05	87.122.05	83.122.05	82.122.05	ST70-7T	91.961.12
FF-961	K961L	85.122.05	84.122.05	87.122.05	83.122.05	82.122.05	ST70-7T	92.961.12
FF-981	K981R	85.122.05	84.122.05	87.122.05	83.122.05	82.122.05	ST70-7T	92.961.12
RIDEWELL KIT NO. 1660106	KG931R	85.122.05	84.122.05	87.122.05	83.122.05	82.122.05	ST70-7T	91.931.18
FG-931, FG-941, FG-943, 17100, 17101, MFS13-143A, MFS13-144A, MFS14-143A	KG931R	85.122.05	84.122.05	87.122.05	83.122.05	82.122.05	ST70-7T	92.931.18
FL-931, FL-941	KH931L	85.931.12	84.931.12	87.931.12	83.931.12	82.931.12	ST70-12T	92.931.12
FH-941, FH-945, FH-946	KH946R	85.122.05	84.122.05	87.122.05	83.122.05	82.122.05	ST70-7T	92.946.18

★ This cutter kit is not included in 85.999.99 or 95.999.99

For tighter fitting bushings, consider ordering any of the APE kits, or sleeves in the tight fit configuration by adding a letter 'T' to the end of the part number. Carbide Reamers are available for extreme applications.

STEMCO®

UNITED STATES | 800-527-8492 | 903-758-9981
300 Industrial Drive
Longview, Texas 75602 | US

4641 Industrial Drive
Millington, Michigan 48746 | US

CANADA | 877-232-9111 | 905-206-9700
1020 Lorimar Drive
Mississauga, ON L5S 1R8 | Canada

MEXICO | 444-804-1736
Eje Central Sahop No 215, Zona Ind
San Luis Potosi SLP 78395 | Mexico

AUSTRALIA, NEW ZEALAND, PAPUA
011-61-2-9793-2599
2/198 Walters Road
Arndell Park NSW 2148 | Australia



STEMCO®

Making the Roadways Safer®

Learn more at [stemco.com](https://www.stemco.com)